

thermrad[®]



Radiatorer

Quickguide

solar

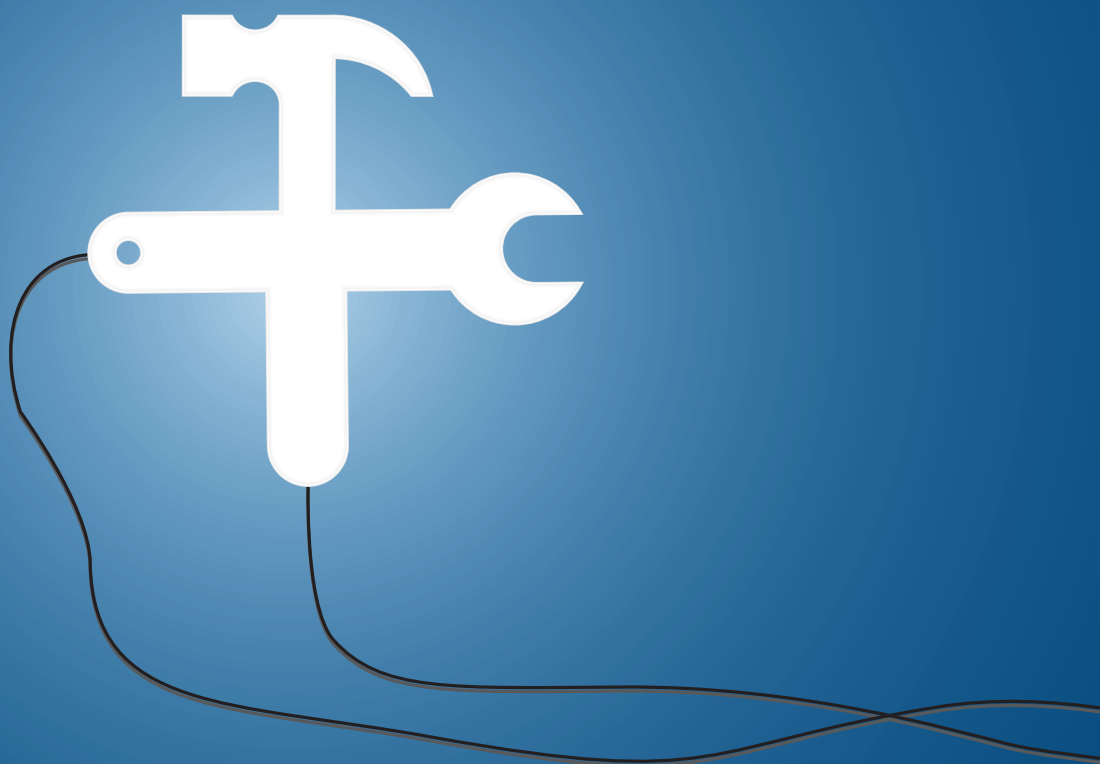

Solar Plus håndværktøj

- Lavere listepreiser end tilsvarende mærker
- Samme eller højere kvalitet end tilsvarende mærker
- Kan leveres inden for maks. 1 dag, natlevering eller via Fastbox

solar.dk/solarplus

solar | plus⁺

Indholdsfortegnelse

- 
- 5 Compact4 tekniske data
 - 6 Compact4 måleskitser
 - 7 Compact4 højde 300 mm
 - 8 Compact4 højde 400 mm
 - 9 Compact4 højde 500 mm
 - 10 Compact4 højde 600 mm
 - 11 Compact4 højde 700 mm
 - 12 Compact4 højde 900 mm
 - 13 Ekstra tilbehør Compact4
 - 14 Compact4 Plan tekniske data
 - 15 Compact4 Plan måleskitser
 - 16 Compact4 Plan højde 400 & 500 mm
 - 17 Compact4 Plan højde 600 & 900 mm
 - 18 Ekstra tilbehør Compact4 Plan
 - 19 Super8 tekniske data
 - 20 Super8 måleskitser
 - 21 Super8 højde 300 mm
 - 22 Super8 højde 400 mm
 - 23 Super8 højde 500 mm
 - 24 Super8 højde 600 mm
 - 25 Super8 højde 700 mm
 - 26 Super8 højde 900 mm
 - 27 Ekstra tilbehør Super8
 - 28 Super8 Plan tekniske data
 - 29 Super8 Plan måleskitser
 - 30 Super8 Plan tilslutningsskitse & højde 300
 - 31 Super8 Plan højde 400 mm
 - 32 Super8 Plan højde 500 mm
 - 33 Super8 Plan højde 600 mm
 - 34 Super8 Plan højde 700 & 900 mm
 - 35 Ekstra tilbehør Super8 Plan
 - 36 Super8 lavkonvektor teknisk beskrivelse
 - 37 Super8 lavkonvektor højde 200 mm
 - 38 Super8 Plan lavkonvektor højde 200 mm
 - 39 Ekstra tilbehør Super8 lavkonvektor
 - 40 Vertical tekniske data
 - 41 Vertical Compact, Vertical Plan og Vertical Line
 - 42 Ekstra tilbehør Vertical
 - 43 Basic4 håndklæderadiator, krom
 - 44 Basic4 håndklæderadiator, hvid
 - 45 Basic 6 håndklæderadiator
 - 46 Lina håndklæderadiator rustfri
 - 47 Tilbehør håndklæderadiatorer krom & hvid
 - 48 Præisoleret rør
 - 49 Præisoleret rør PN6 til varme & PN10 til vand
 - 50 Fittings PN6 til varme & PN10 til vand
 - 51 Tilbehør præisoleret rør

Thermrad radiatorserien består af 7 radiatormodeller

Compact4 i typerne 11, 21, 22 og 33 og alle med profileret front og monteret med sidepaneler og toprist.

Compact4 Plan i typen 22 og alle med påmonteret plan front, sidepaneler og toprist.

Super8 i typerne 11, 20, 21, 22 og 33 og alle med indbygget ventil sæt (altid højrevendt) profileret front og monteret med sidepaneler og toprist.

Super8 Plan i typerne 11, 21, 22 og 33 og alle med indbygget ventil sæt (altid højrevendt) påmonteret plan front, sidepaneler og toprist.

Super8 lavkonvektor i typerne 22 og 33 og alle med indbygget ventil sæt, profileret front og påmonterede sidepaneler og toprist. Er vendbar/valgfri ventilorientering, da den er uden bærebøjler og monteres med fjederkonsoller eller ben.

Vertical i typerne 21 og 22 i modellerne Vertical Standard med profileret front, Vertical Plan med plan front og Vertical Line plan med profileret plan front.

Håndklæderadiatorer i 10 forskellige modeller i farverne hvid, krom, antracit, rustfri poleret og rustri børstet.

Da Thermrad radiatorer produceres på 3 forskellige fabrikker kan der forekomme farvenuance de enkelte modeller imellem. Ligeledes er gavl og toprist på Compact4 og Super8 radiatorer ikke 100% identisk.

Compact4

Thermrad Compact4 er en klassisk panelradiator, som leveres med top- og sidepanel.

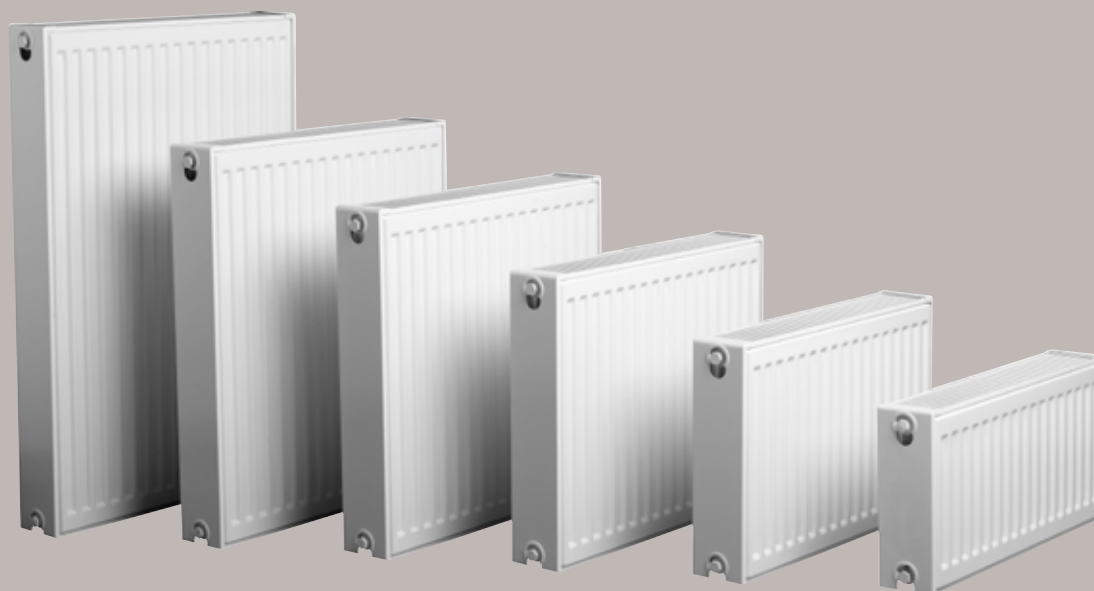

Tekniske data

Konstruktion	Iht. EN442-1
Materiale	Koldvalset stålplade iht. EN 10130
Overfladebehandling	Overfladebehandling i fem faser: <ul style="list-style-type: none">· Alkalisk affedtning· Fosfatering· Rustbeskyttende grundmaling· Polyester-epoxy pulverlakering· Pulverlakering brændt ved 210 grader
Farve	RAL 9016
Driftstryk	10 bar
Anboring	4 x 1/2" anboringer iht. ISO 228
Højder	300 – 400 – 500 – 600 og 900 mm
Typer	Type 11 – enkeltplade med en konvektionslamel Type 21 – dobbeltplade med en konvektionslamel Type 22 – dobbeltplade med to konvektionslameller Type 33 – tredobbeltplade med tre konvektionslameller
Garanti	Der ydes 10 års garanti på defekter forårsaget af materiale- eller produktionsfejl.
Medleveret tilbehør	Leveres med bæringer inkl. skruer og plugs, luftskrue, blindprop og aftapsventil.

Compact4

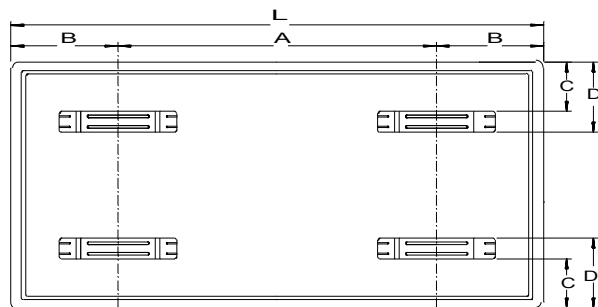
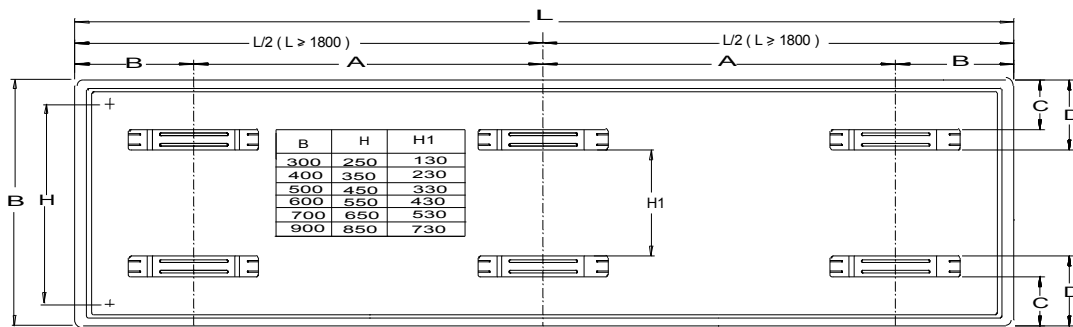

L Radiator længde	KONSOL PLACERING						Antal bæring
	A (mm)		B (mm)		C (mm)	D (mm)	
	Type 11	Type 21-22-33	Type 11	Type 21-22-33			
400	166	134	117	133	60	85	2
500	200	234	150	133	60	85	2
600	300	334	150	133	60	85	2
700	400	434	150	133	60	85	2
800	500	534	150	133	60	85	2
900	600	634	150	133	60	85	2
1000	700	734	150	133	60	85	2
1100	800	834	150	133	60	85	2
1200	900	934	150	133	60	85	2
1400	1100	1134	150	133	60	85	2
1600	1300	1334	150	133	60	85	2
1800	767	767	150	133	60	85	3
2000	867	867	150	133	60	85	3
2200	967	967	150	133	60	85	3
2400	1067	1067	150	133	60	85	3
2600	1167	1167	150	133	60	85	3
2700	1217	1217	150	133	60	85	3
2800	1267	1267	150	133	60	85	3
3000	1367	1367	150	133	60	85	3

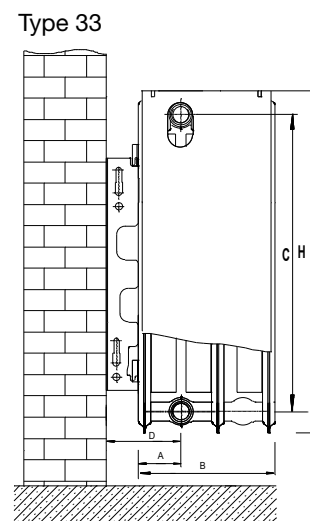
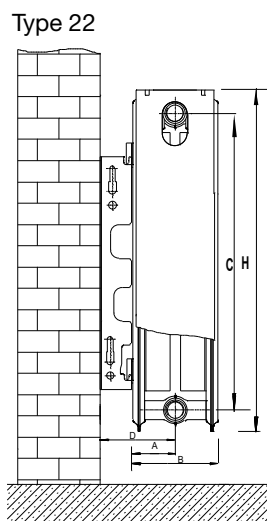
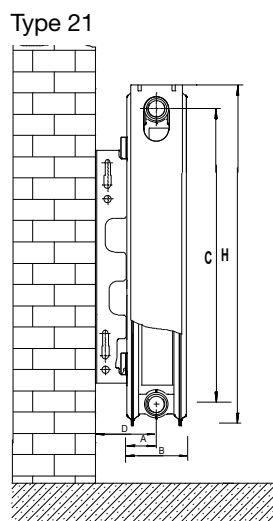
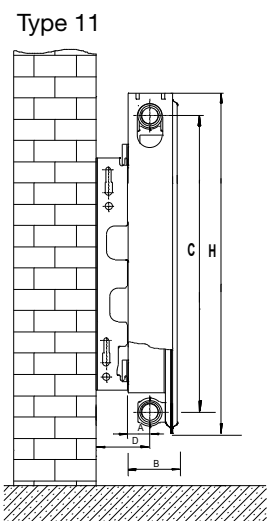
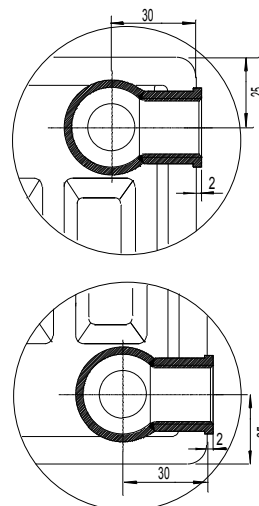
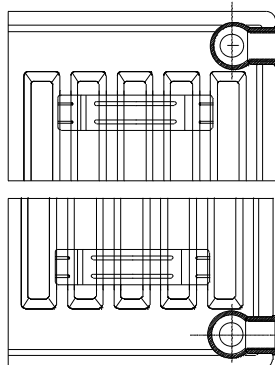
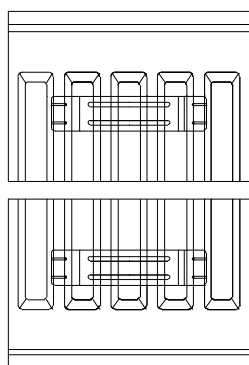
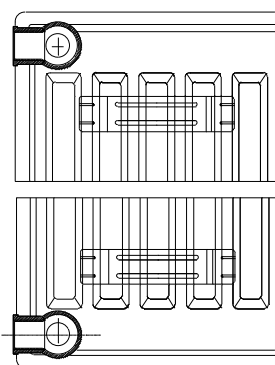

A=29,6
B=61
C=H-50
D= 56,5

A=38,5
B=77
C=H-50
D= 65,5

A=50
B=100
C=H-50
D= 78

A=50
B=160
C=H-50
D= 78



Compact4 højde 300 mm

Type	VVS-Nr.	Ydelse 70/40/20	Ydelse 60/40/20	Ydelse 45/35/20	Vægt
11-300-500*	32.8631.535	169	139	83	4,65
11-300-1200*	32.8631.542	407	334	198	11,16
11-300-1400*	32.8631.544	475	389	231	13,02
11-300-1800*	32.8631.548	610	501	297	16,74
21-300-500*	32.8633.535	245	201	118	7,24
21-300-1000*	32.8633.540	482	401	235	14,48
21-300-1400*	32.8633.544	688	562	329	20,27
21-300-2000*	32.8633.550	983	802	470	28,96
22-300-500*	32.8634.535	307	251	148	7,59
22-300-600*	32.8634.536	369	302	177	9,10
22-300-800*	32.8634.538	492	402	236	12,14
22-300-1000*	32.8634.540	615	503	295	15,17
22-300-1200	32.8634.542	738	603	354	18,24
22-300-1400*	32.8634.544	861	704	416	21,24
22-300-1600*	32.8634.546	984	804	472	24,27
22-300-1800*	32.8634.548	1107	905	531	27,31
22-300-2000	32.8634.550	1230	1005	590	30,34
22-300-2200*	32.8634.552	1320	1106	649	33,37
22-300-2400*	32.8634.554	1476	1200	709	36,41
22-300-2600*	32.8634.556	1566	1307	768	39,44
22-300-2800*	32.8634.558	1722	1408	827	42,48
22-300-3000	32.8634.560	1845	1508	886	45,51
33-300-800*	32.8636.538	702	575	339	18,06
33-300-1000*	32.8636.540	878	719	429	22,57
33-300-1200*	32.8636.542	1053	862	508	27,08
33-300-1400*	32.8636.544	1229	1009	593	31,60
33-300-1600*	32.8636.546	1404	1150	678	36,11
33-300-1800*	32.8636.548	1580	1293	763	40,63
33-300-2000*	32.8636.550	1756	1437	847	45,14
33-300-2400*	32.8636.554	2107	1725	1017	54,17
33-300-2600*	32.8636.556	2282	1868	1102	58,68

* Leveringstid 4-8 arbejdsdage

Compact4 højde 400 mm

Type	VVS-Nr.	Ydelse 70/40/20	Ydelse 60/40/20	Ydelse 45/35/20	Vægt
11-400-400*	32.8641.534	178	146	86	5,00
11-400-500*	32.8641.535	222	183	108	6,30
11-400-600*	32.8641.536	267	219	130	7,56
11-400-700*	32.8641.537	310	242	151	8,82
11-400-800*	32.8641.538	356	292	173	10,08
11-400-900*	32.8641.539	400	328	195	11,34
11-400-1000*	32.8641.540	445	365	217	12,60
11-400-1200*	32.8641.542	534	438	260	15,11
11-400-1400*	32.8641.544	623	611	303	17,63
11-400-1600*	32.8641.546	712	584	346	20,15
11-400-1800*	32.8641.548	801	657	390	22,67
11-400-2000*	32.8641.550	890	730	433	25,19
11-400-2400*	32.8641.554	1068	876	520	30,23
11-400-3000*	32.8641.560	1335	1095	650	37,79

21-400-500*	32.8643.535	313	256	150	10,00
21-400-600*	32.8643.536	376	307	176	12,00
21-400-800*	32.8643.538	486	409	239	16,00
21-400-1000*	32.8643.540	627	511	299	20,00
21-400-1200*	32.8643.542	728	513	359	24,00
21-400-1400*	32.8643.544	877	716	419	28,00
21-400-1600*	32.8643.546	1003	818	479	32,00
21-400-1800*	32.8643.548	1128	920	538	36,00
21-400-2000 *	32.8643.550	1214	1022	598	40,00
21-400-2200*	32.8643.552	1379	1125	658	44,00
21-400-2400*	32.8643.554	1464	1227	718	48,00
21-400-2600*	32.8643.556	1630	1329	778	52,00
21-400-2800*	32.8643.558	1755	1431	838	56,00
21-400-3000*	32.8643.560	1881	1533	897	60,00

22-400-400*	32.8644.534	313	256	149	8,53
22-400-500	32.8644.535	392	320	187	10,67
22-400-600	32.8644.536	471	384	225	12,80
22-400-700*	32.8644.537	549	448	262	14,93
22-400-800	32.8644.538	628	512	299	17,06
22-400-900*	32.8644.539	706	576	337	19,20
22-400-1000	32.8644.540	785	640	374	21,33
22-400-1100*	32.8644.541	863	704	412	23,46
22-400-1200	32.8644.542	942	768	449	25,60
22-400-1400	32.8644.544	1099	896	524	29,86
22-400-1500*	32.8644.545	1177	960	562	32,00
22-400-1600	32.8644.546	1256	1024	599	34,13
22-400-1800*	32.8644.548	1413	1152	674	38,39
22-400-2000	32.8644.550	1570	1281	749	42,66
22-400-2200*	32.8644.552	1672	1409	824	46,93
22-400-2400*	32.8644.554	1824	1537	898	51,19
22-400-2600*	32.8644.556	2041	1665	973	55,46
22-400-2800*	32.8644.558	2128	1793	1048	59,72
22-400-3000*	32.8644.560	2355	1921	1123	63,99

33-400-600*	32.8646.536	674	550	324	19,02
33-400-800	32.8646.538	898	734	431	25,36
33-400-1000	32.8646.540	1123	917	539	31,70
33-400-1200	32.8646.542	1347	1101	647	38,04
33-400-1400*	32.8646.544	1572	1284	755	44,38
33-400-1600	32.8646.546	1796	1468	863	50,72
33-400-1800	32.8646.548	2021	1651	971	57,06
33-400-2000*	32.8646.550	2246	1835	1079	63,40
33-400-2200*	32.8646.552	2470	2018	1186	69,74

* Leveringstid 4-8 arbejdsdage

Compact4 højde 500 mm

Type	VVS-Nr.	Ydelse 70/40/20	Ydelse 60/40/20	Ydelse 45/35/20	Vægt
11-500-400	32.8651.534	218	179	106	6,13
11-500-500	32.8651.535	272	223	132	7,67
11-500-600	32.8651.536	327	268	159	9,20
11-500-800	32.8651.538	436	357	212	12,26
11-500-1000	32.8651.540	545	447	264	15,33
11-500-1200*	32.8651.542	654	536	317	18,40
11-500-1400*	32.8651.544	763	625	370	21,46
11-500-1600*	32.8651.546	872	715	423	24,53
11-500-1800*	32.8651.548	981	804	476	27,59
11-500-2000*	32.8651.550	1090	893	529	30,66
11-500-2200*	32.8651.552	1199	982	582	33,73
11-500-2400*	32.8651.554	1308	1072	635	36,79
11-500-2600*	32.8651.556	1417	1161	688	39,86

21-500-500	32.8653.535	376	306	179	12,16
21-500-600*	32.8653.536	450	368	215	14,59
21-500-800	32.8653.538	600	490	286	19,45
21-500-1000*	32.8653.540	751	613	358	24,31
21-500-1200*	32.8653.542	901	735	429	29,17
21-500-1400*	32.8653.544	1051	858	501	34,03
21-500-1600*	32.8653.546	1201	980	572	38,90
21-500-1800*	32.8653.548	1351	1103	644	43,76
21-500-2000*	32.8653.550	1502	1225	716	48,62
21-500-2400*	32.8653.554	1802	1470	859	58,34

22-500-400	32.8654.534	376	306	178	10,52
22-500-500	32.8654.535	470	383	223	13,15
22-500-600	32.8654.536	564	459	267	15,78
22-500-700	32.8654.537	658	536	312	18,41
22-500-800	32.8654.538	752	612	356	21,01
22-500-900	32.8654.539	846	689	401	23,67
22-500-1000	32.8654.540	940	765	445	26,30
22-500-1100	32.8654.541	1034	842	480	28,93
22-500-1200	32.8654.542	1128	918	534	31,56
22-500-1400	32.8654.544	1316	1071	623	36,82
22-500-1500	32.8654.545	1410	1148	668	39,45
22-500-1600	32.8654.546	1504	1224	713	42,08
22-500-1800	32.8654.548	1692	1377	802	47,34
22-500-2000	32.8654.550	1880	1530	891	52,60
22-500-2200	32.8654.552	2068	1683	980	57,86
22-500-2400	32.8654.554	2256	1836	1069	63,12
22-500-2600	32.8654.556	2444	1989	1158	63,38
22-500-2800*	32.8654.558	2632	2142	1247	73,64
22-500-3000*	32.8654.560	2820	2295	1336	78,90

33-500-500*	32.8656.535	673	549	322	19,58
33-500-600*	32.8656.536	807	659	387	23,49
33-500-700*	32.8656.537	884	769	451	27,41
33-500-800*	32.8656.538	1077	879	515	31,32
33-500-1000	32.8656.540	1346	1099	644	39,15
33-500-1100*	32.8656.541	1480	1209	709	43,07
33-500-1200	32.8656.542	1615	1319	773	46,98
33-500-1400*	32.8656.544	1884	1538	902	54,81
33-500-1600*	32.8656.546	2153	1758	1031	62,64
33-500-2000*	32.8656.550	2692	2198	1288	78,30
33-500-2400*	32.8656.554	3024	2637	1546	93,96

* Leveringstid 4-8 arbejdsdage

Compact4 højde 600 mm

Type	VVS-Nr.	Ydelse 70/40/20	Ydelse 60/40/20	Ydelse 45/35/20	Vægt
11-600-400	32.8661.534	255	209	124	7,45
11-600-500	32.8661.535	319	262	155	9,31
11-600-600	32.8661.536	383	314	186	11,17
11-600-700	32.8661.537	447	366	217	13,03
11-600-800	32.8661.538	511	419	248	14,90
11-600-900	32.8661.539	575	471	278	16,76
11-600-1000	32.8661.540	639	523	309	18,62
11-600-1200	32.8661.542	766	628	371	22,34
11-600-1400	32.8661.544	894	732	433	26,07
11-600-1600	32.8661.546	1022	837	495	29,79
11-600-1800*	32.8661.548	1150	942	557	33,52
11-600-2000*	32.8661.550	1278	1046	619	37,24
11-600-2200*	32.8661.552	1402	1151	681	40,96
11-600-2400*	32.8661.554	1533	1256	743	44,69

21-600-500	32.8663.535	434	353	206	14,89
21-600-700	32.8663.537	607	495	288	20,84
21-600-800	32.8663.538	694	565	330	23,82
21-600-900	32.8663.539	781	636	371	26,79
21-600-1000	32.8663.540	868	707	412	29,77
21-600-1200	32.8663.542	1041	848	495	35,72
21-600-1400*	32.8663.544	1215	990	577	41,68
21-600-1600*	32.8663.546	1388	1131	659	47,63
21-600-1800*	32.8663.548	1506	1272	742	53,59
21-600-2000*	32.8663.550	1736	1414	824	59,54

22-600-400	32.8664.534	432	351	204	12,96
22-600-500	32.8664.535	541	439	255	16,20
22-600-600	32.8664.536	648	527	305	19,44
22-600-700	32.8664.537	756	615	356	22,68
22-600-800	32.8664.538	864	703	407	25,92
22-600-900	32.8664.539	972	791	458	29,16
22-600-1000	32.8664.540	1081	879	509	32,40
22-600-1100	32.8664.541	1189	966	560	35,64
22-600-1200	32.8664.542	1297	1054	611	38,88
22-600-1400	32.8664.544	1514	1230	713	45,36
22-600-1500	32.8664.545	1621	1318	764	48,60
22-600-1600	32.8664.546	1729	1406	815	51,84
22-600-1800	32.8664.548	1945	1581	916	58,32
22-600-2000	32.8664.550	2162	1757	1018	64,80
22-600-2200	32.8664.552	2379	1933	1120	71,28
22-600-2400	32.8664.554	2594	2109	1222	77,76
22-600-2600	32.8664.556	2810	2284	1324	84,24
22-600-3000	32.8664.560	3243	2636	1527	97,20

33-600-600*	32.8666.536	929	758	443	28,99
33-600-700*	32.8666.537	1019	884	517	33,82
33-600-800	32.8666.538	1239	1011	591	38,66
33-600-1000	32.8666.540	1549	1263	738	48,31
33-600-1200	32.8666.542	1858	1516	886	57,98
33-600-1600	32.8666.546	2478	2021	1182	77,31
33-600-1800	32.8666.548	2788	2274	1329	86,98

* Leveringstid 4-8 arbejdsdage

Compact4 højde 700 mm

Type	VVS-Nr.	Ydelse 70/40/20	Ydelse 60/40/20	Ydelse 45/35/20	Vægt
11-700-400*	32.8671.534	290	238	141	8,35
11-700-500*	32.8671.535	363	297,5	176	10,44
11-700-600*	32.8671.536	436	357	211	15,52
11-700-800*	32.8671.538	581	476	282	16,69
11-700-1000*	32.8671.540	726	595	352	20,87
11-700-1200*	32.8671.542	871	714	422	25,04
11-700-1600*	32.8671.546	1162	982	563	33,39
21-700-500*	32.8673.535	486	395	229	16,50
21-700-600*	32.8673.536	584	474	275	19,80
21-700-800*	32.8673.538	778	632	367	26,40
21-700-1000*	32.8673.540	973	791	459	33,03
21-700-1200*	32.8673.542	1167	949	550	39,60
22-700-400*	32.8674.534	314	395	229	14,56
22-700-500*	32.8674.535	393	493	286	18,20
22-700-600*	32.8674.536	471	592	343	21,84
22-700-700*	32.8674.537	486	691	400	25,20
22-700-800*	32.8674.538	972	789	457	28,80
22-700-900*	32.8674.539	1093	888	515	32,40
22-700-1000*	32.8674.540	1215	987	572	36,42
22-700-1100*	32.8674.541	1336	1085	629	39,60
22-700-1200*	32.8674.542	1458	1184	686	43,20
22-700-1400*	32.8674.544	1701	1381	801	50,40
22-700-1600*	32.8674.546	1944	1579	915	57,60
22-700-1800*	32.8674.548	2187	1776	1029	64,80
22-700-2000*	32.8674.550	2430	1974	1144	72,00
33-700-500*	32.8676.535	868	707	413	27,10
33-700-600*	32.8676.536	1042	849	495	32,52
33-700-700*	32.8676.537	1215	990	578	37,94
33-700-800*	32.8676.538	1389	1132	660	43,36
33-700-1000*	32.8676.540	1736	1415	826	54,28
33-700-1200*	32.8676.542	2083	1698	991	65,04











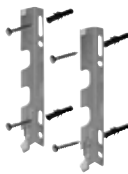















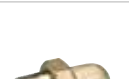

* Leveringstid 4-8 arbejdsdage

Compact4 højde 900 mm

Type	VVS-Nr.	Ydelse 70/40/20	Ydelse 60/40/20	Ydelse 45/35/20	Vægt
11-900-400*	32.8691.534	357	289	171	10,68
11-900-500*	32.8691.535	441	361	213	13,35
11-900-600*	32.8691.536	529	433	256	16,02
11-900-800*	32.8691.538	706	577	341	21,36
11-900-1000*	32.8691.540	882	722	427	26,76
21-900-400*	32.8693.534	462	376	216	17,00
21-900-500*	32.8693.535	580	469	270	21,25
21-900-600*	32.8693.536	696	563	324	25,50
21-900-700*	32.8693.537	812	657	378	29,75
21-900-800*	32.8693.538	928	751	432	34,00
21-900-1000*	32.8693.540	1154	939	540	42,56
22-900-400	32.8694.534	580	471	273	18,92
22-900-500	32.8694.535	725	589	341	23,65
22-900-600	32.8694.536	870	707	410	28,38
22-900-700*	32.8694.537	1015	825	478	33,11
22-900-800	32.8694.538	1160	943	546	37,84
22-900-900*	32.8694.539	1325	1061	614	42,57
22-900-1000	32.8694.540	1450	1179	683	47,31
22-900-1200*	32.8694.542	1740	1414	820	56,76
22-900-1400*	32.8694.544	2030	1650	956	66,22
22-900-1600*	32.8694.546	2356	1886	1093	75,68
33-900-400	32.8696.534	824	670	389	28,20
33-900-500	32.8696.535	1029	837	487	35,25
33-900-600	32.8696.536	1235	1005	584	42,30
33-900-700	32.8696.537	1441	1173	681	49,35
33-900-800	32.8696.538	1647	1340	779	56,40
33-900-900	32.8696.539	1853	1507	876	63,45
33-900-1000	32.8696.540	2058	1675	974	70,56
33-900-1200	32.8696.542	2470	2010	1168	84,60

* Leveringstid 4-8 arbejdsdage

Ekstra tilbehør Compact4

	Type	VVS-nr.		Type	VVS-nr.
	SOLAR PLUS BÆRINGSSÆT TIL HØJDE 300 MM	32.1144.003		 RADIATOR FØLERELEMENT M30X1,5 148A	40.3822.000
	SOLAR PLUS BÆRINGSSÆT TIL HØJDE 400 MM	32.1144.104		 RADIATORVENTIL 1/2" LIGE. 179WM	40.3800.004
	SOLAR PLUS BÆRINGSSÆT TIL HØJDE 500 MM	32.1144.105		 RADIATORVENTIL 1/2" VINKEL- LØBENDE. 178WM	40.3801.004
	SOLAR PLUS BÆRINGSSÆT TIL HØJDE 600 MM	32.1144.106		 RADIATORVENTIL 1/2" OMV. VINKELL. 134M 12WM	40.3803.004
	SOLAR PLUS BÆRINGSSÆT TIL HØJDE 700 MM	32.1144.107		 TILSLUTNINGSRØR 1/2"X 15MMX150MM	40.2179.515
	SOLAR PLUS BÆRINGSSÆT TIL HØJDE 900 MM	32.1144.109		 VSH KLEMRING 15MM STÅL/CUX 3/4" EURO TIL TILSL.RØR 40.2179.515	40.2179.315
	THERMRAD FJEDERKONSOL HØJDE 300 MM	32.2244.103	 1/2" LUFTSKRUE MESSING	40.5501.104	
	THERMRAD FJEDERKONSOL HØJDE 400 MM	32.2244.104	 1/2" LUFTSKRUE MED O-RING FORKROMET	40.5524.004	
	THERMRAD FJEDERKONSOL HØJDE 500 MM	32.2244.105	 1/2" RADIATORPROP MED O-RING	40.5494.004	
	THERMRAD FJEDERKONSOL HØJDE 600 MM	32.2244.106	 NØGLE TIL LUFTSKRUE	40.5516.000	
	THERMRAD FJEDERKONSOL HØJDE 700 MM	32.2244.107	 UNIVERSAL LUFTSKRUE- NØGLE 4-VEJS	40.5719.000	
	THERMRAD FJEDERKONSOL HØJDE 900 MM	32.2244.109	 1/2 BUNDHANE N/N M/ SLUTMUFFE	40.7105.004	
	THERMRAD C4 GULVBEN TYPE 22-33 (SÆT)	32.1045.100	 RADIATORFORSKRUNING LIGEL. 3/8	40.5000.003	
	THERMRAD C4 GULVBEN TYPE 20-21 (SÆT)	32.1045.103	 RADIATORFORSKRUNING LIGEL. 1/2	40.5000.004	
	THERMRAD GULVROSET TIL KONVEKTORBEN	32.1044.110	 RADIATORFORSKRUNING VINKEL 3/8	40.5001.003	
	3/8" TERMOSTATVENTIL LIGE AV9	40.3528.110	 RADIATORFORSKRUNING VINKEL 1/2	40.5001.004	
	1/2" TERMOSTATVENTIL LIGE AV9	40.3528.115	 RADIATORSPRING 2-DELT AFKORTELEG	40.5570.004	
	3/8" TERMOSTATVENTIL VINKEL AV9	40.3528.010		RADIATORSPRING EXCEN- TRISK FORSKYDNING 20 MM	40.5970.020
	1/2" TERMOSTATVENTIL VINKEL AV9	40.3528.015		RADIATORSPRING EXCEN- TRISK FORSKYDNING 30 MM	40.5970.030
	1/2" TERMOSTATVENTIL OMV. VINKEL AV9	40.3525.215		RADIATORSPRING EXCEN- TRISK FORSKYDNING 50 MM	40.5970.050
	FØLERELEMENT M30 HVID STANDARD UNI LH	40.3431.013		PÅFYLDNINGSSLANGE CENTRALVARME. 3,5M,	37.1103.002
	FØLERELEMENT UNI LD PASSER T. DANFOS RA	40.3431.030			

Compact4 Plan

Thermrad Compact4 Plan er en klassisk panelradiator, som leveres med påmonteret plan front, gavle og riste.



Tekniske data

Konstruktion	Iht. EN442-1
Materiale	Koldvalset stålplade iht. EN 10130
Overfladebehandling	Overfladebehandling i fem faser: <ul style="list-style-type: none">· Alkalisk affedtning· Fosfatering· Rustbeskyttende grundmaling· Polyester-epoxy pulverlakering· Pulverlakering brændt ved 210 grader
Farve	RAL 9016
Driftstryk	10 bar
Anboring	4 x ½" anboringer iht. ISO 228
Højder	400 – 500 – 600 og 900 mm
Typer	Type 22 – dobbeltplade med to konvektionslameller
Garanti	Der ydes 10 års garanti på defekter forårsaget af materiale eller produktionsfejl.
Medleveret tilbehør	Leveres med bæringer inkl. skruer og plugs, luftskrue, blindprop og aftapsventil.

Compact4 Plan

C4 PLAN

T 22

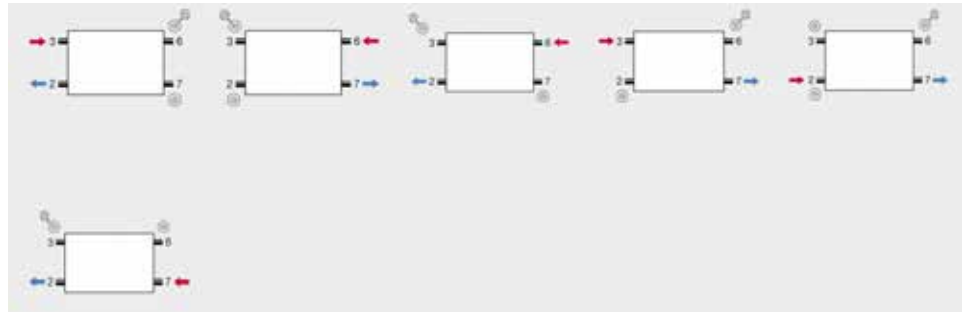
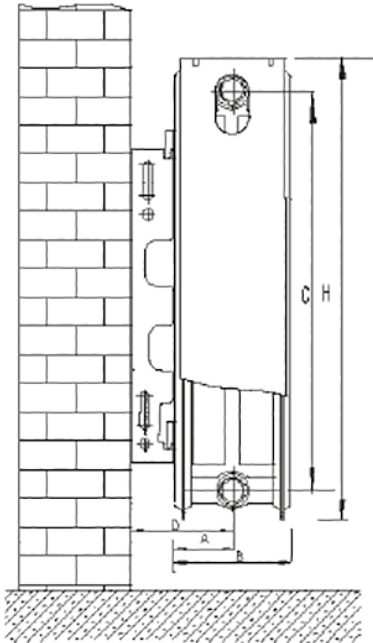

A=50
B=104
C=H-50
D=92,5/78

Position of the mounting strips

LENGTH RAD	A (mm)	B (mm)	C (mm)	D (mm)	NR. OF BRACKETS
400	134	133	60	85	2
500	234	133	60	85	2
600	334	133	60	85	2
700	434	133	60	85	2
800	534	133	60	85	2
900	634	133	60	85	2
1000	734	133	60	85	2
1100	834	133	60	85	2
1200	934	133	60	85	2
1400	1134	133	60	85	2
1600	1334	133	60	85	2
1800	767	133	60	85	3
2000	867	133	60	85	3
2200	967	133	60	85	3
2400	1067	133	60	85	3
2600	1167	133	60	85	3
2700	1217	133	60	85	3
2800	1267	133	60	85	3
3000	1367	133	60	85	3

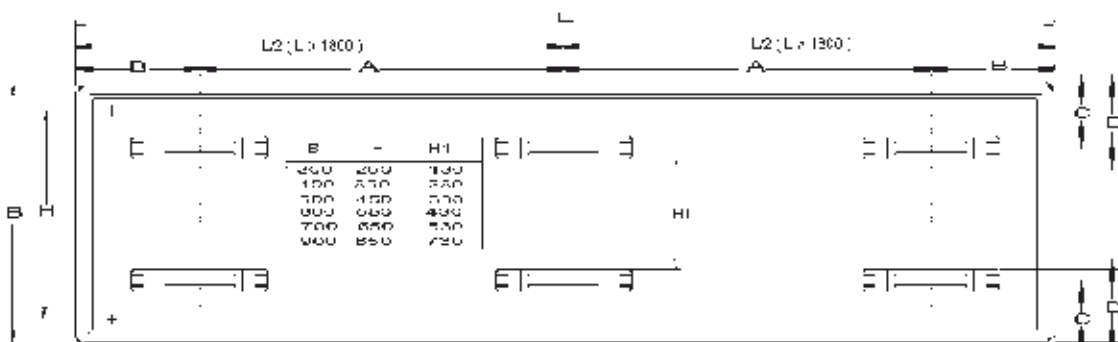
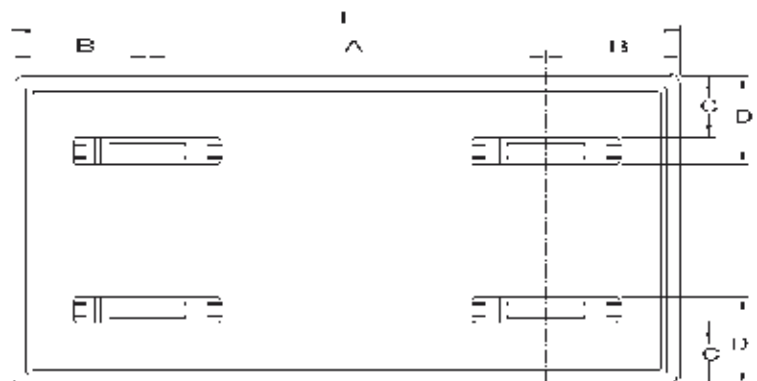

Compact4 Plan højde 400 mm

Type	VVS-Nr.	Ydelse 70/40/20	Ydelse 60/40/20	Ydelse 45/35/20	Vægt
11-400-400*	32.8641.534	178	146	86	5,00
11-400-500*	32.8641.535	222	183	108	6,30
11-400-600*	32.8641.536	267	219	130	7,56
11-400-700*	32.8641.537	310	242	151	8,82
11-400-800*	32.8641.538	356	292	173	10,08
11-400-900	32.8641.539	400	328	195	11,34
11-400-1000*	32.8641.540	445	365	217	12,60
11-400-1200	32.8641.542	534	438	260	15,11
11-400-1400*	32.8641.544	623	611	303	17,63
11-400-1600*	32.8641.546	712	584	346	20,15
11-400-1800*	32.8641.548	801	657	390	22,67
11-400-2000*	32.8641.550	890	730	433	25,19
11-400-2400*	32.8641.554	1068	876	520	30,23
11-400-3000*	32.8641.560	1335	1095	650	37,79

* Leveringstid 4-8 arbejdsdage

Compact4 Plan højde 500 mm

Type	VVS-Nr.	Ydelse70/40/20	Ydelse60/40/20	Ydelse45/35/20	Vægt
22-500-500*	32.8654.205	218	179	106	6,13
22-500-600	32.8654.206	272	223	132	7,67
22-500-700*	32.8654.207	327	268	159	9,20
22-500-800*	32.8654.208	436	357	212	12,26
22-500-900*	32.8654.209	545	447	264	15,33
22-500-1000	32.8654.210	654	536	317	18,40
22-500-1100*	32.8654.211	763	625	370	21,46
22-500-1200	32.8654.212	872	715	423	24,53
22-500-1400	32.8654.214	981	804	476	27,59
22-500-1600*	32.8654.216	1090	893	529	30,66
22-500-1800*	32.8654.218	1199	982	582	33,73
22-500-2000*	32.8654.220	1308	1072	635	36,79

* Leveringstid 4-8 arbejdsdage

Compact4 Plan højde 600 mm

Type	VVS-Nr.	Ydelse 70/40/20	Ydelse 60/40/20	Ydelse 45/35/20	Vægt
22-600-500*	32.8664.205	495	403	234	18,80
22-600-600	32.8664.206	593	483	281	22,56
22-600-700*	32.8664.207	692	564	328	26,32
22-600-800	32.8664.208	791	644	375	30,08
22-600-900*	32.8664.209	890	725	422	33,84
22-600-1000	32.8664.210	989	805	469	37,65
22-600-1100*	32.8664.211	1088	886	516	41,36
22-600-1200	32.8664.212	1187	966	562	45,12
22-600-1400*	32.8664.214	1385	1127	656	52,64
22-600-1600*	32.8664.216	1583	1288	750	60,16
22-600-1800*	32.8664.218	1780	1449	844	67,68
22-600-2000*	32.8664.220	1978	1610	937	75,20





















* Leveringstid 4-8 arbejdsdage

Compact4 Plan højde 900 mm

Type	VVS-Nr.	Ydelse 70/40/20	Ydelse 60/40/20	Ydelse 45/35/20	Vægt
22-900-400*	32.8694.204	518	422	246	23,04
22-900-500*	32.8694.205	648	527	307	28,80
22-900-600*	32.8694.206	777	633	369	34,56
22-900-700*	32.8694.207	907	738	430	40,32

* Leveringstid 4-8 arbejdsdage

Ekstra tilbehør Compact4 Plan

	Type	VVS-nr.		Type	VVS-nr.
	SOLAR PLUS BÆRINGSSÆT TIL HØJDE 400 MM	32.1144.104		TILSLUTNINGSRØR 1/2"X 15MMX150MM	40.2179.515
	SOLAR PLUS BÆRINGSSÆT TIL HØJDE 500 MM	32.1144.105		VSH KLEMRING 15MM STÅL/CUX 3/4"EURO TIL TILSL-RØR 40.2179.515	40.2179.315
	SOLAR PLUS BÆRINGSSÆT TIL HØJDE 600 MM	32.1144.106		1/2" LUFTSKRUE MESSING	40.5501.104
	SOLAR PLUS BÆRINGSSÆT TIL HØJDE 900 MM	32.1144.109		1/2" LUFTSKRUE MED O-RING FORKROMET	40.5524.004
	THERMRAD FJEDERKONSOL HØJDE 400 MM	32.2244.104		1/2" RADIATORPROP MED O-RING	40.5494.004
	THERMRAD FJEDERKONSOL HØJDE 500 MM	32.2244.105		NØGLE TIL LUFTSKRUE	40.5516.000
	THERMRAD FJEDERKONSOL HØJDE 600 MM	32.2244.106		UNIVERSAL LUFTSKRUE- NØGLE 4-VEJS	40.5719.000
	THERMRAD FJEDERKONSOL HØJDE 900 MM	32.2244.109		1/2 BUNDHANE N/N M/ SLUTMUFFE	40.7105.004
	THERMRAD C4 GULVBEN TYPE 22-33 (SÆT)	32.1045.100		RADIATORFORSKRUNING LIGEL. 3/8	40.5000.003
	THERMRAD C4 GULVBEN TYPE 20-21 (SÆT)	32.1045.103		RADIATORFORSKRUNING LIGEL. 1/2	40.5000.004
	THERMRAD GULVROSET TIL KONVEKTORBEN	32.1044.110		RADIATORFORSKRUNING VINKEL 3/8	40.5001.003
	3/8" TERMOSTATVENTIL LIGE AV9	40.3528.110		RADIATORFORSKRUNING VINKEL 1/2	40.5001.004
	1/2" TERMOSTATVENTIL LIGE AV9	40.3528.115		RADIATORSPRING 2-DELT AFKORTELEG	40.5570.004
	3/8" TERMOSTATVENTIL VINKEL AV9	40.3528.010		RADIATORSPRING EXCEN- TRISK FORSKYDNING 20 MM	40.5970.020
	1/2" TERMOSTATVENTIL VINKEL AV9	40.3528.015		RADIATORSPRING EXCEN- TRISK FORSKYDNING 30 MM	40.5970.030
	1/2" TERMOSTATVENTIL OMV. VINKEL AV9	40.3525.215		RADIATORSPRING EXCEN- TRISK FORSKYDNING 50 MM	40.5970.050
		FØLERELEMENT M30 HVID STANDARD UNI LH	40.3431.013		PÅFYLDNINGSSLANGE CENTRALVARME. 3,5M,
	FØLERELEMENT UNI LD PASSER T. DANFOS RA	40.3431.030			
	RADIATOR FØLERELEMENT M30X1,5 148A	40.3822.000			
	RADIATORVENTIL 1/2" LIGE. 179WM	40.3800.004			
	RADIATORVENTIL 1/2" VINKEL- LØBENDE. 178WM	40.3801.004			
	RADIATORVENTIL 1/2" OMV. VINKELL. 134M 12WM	40.3803.004			

Super8

Thermrad Super8 er en klassisk panelradiator, som leveres med top- og sidepanel. Super8 leveres med integreret ventilsystem, som muliggør tilslutning nedefra. Ventil skal altid placeres i højre side top ved anvendelse af bundanboringer.

Super8 er forsynet med 8 anboringer.



Tekniske data

Konstruktion	Iht. EN442-1
Materiale	Koldvalset stålplade iht. EN 10130
Overfladebehandling	Overfladebehandling i fem faser: <ul style="list-style-type: none">· Alkalisk affedtning· Fosfatering· Rustbeskyttende grundmaling· Polyester-epoxy pulverlakering· Pulverlakering brændt ved 210 grader
Farve	RAL 9016
Driftstryk	10 bar
Anboring	4 x 1/2" hjørneanboringer, anboringer iht. ISO 228 og 4x3/4" eurokonus bundanboringer.
Højder	300 – 400 – 500 – 600 - 700 og 900 mm
Typer	Type 11 – enkeltplade med en konvektionslamel Type 20 – dobbeltplade uden konvektionslameller Type 21 – dobbeltplade med en konvektionslamel Type 22 – dobbeltplade med to konvektionslameller Type 33 – tredobbeltplade med tre konvektionslameller
Garanti	Der ydes 10 års garanti på defekter forårsaget af materiale- eller produktionsfejl.
Medleveret tilbehør	Leveres med bæringer inkl. skruer og plugs, luftskrue, blindprop og aftapsventil og ventil M30.

Super8

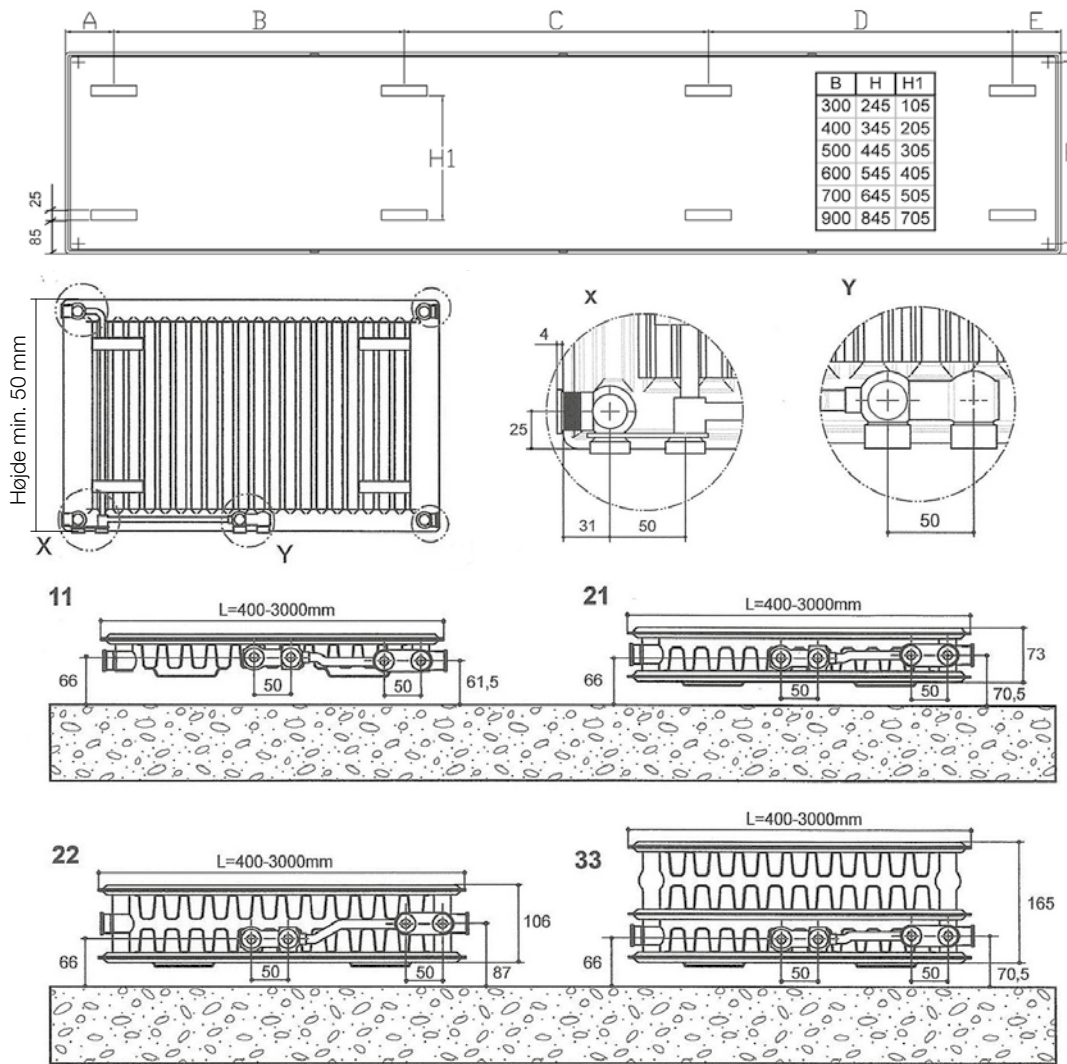

Konsolplacering

Længde radiator	A	B	C	D	E
400	116				116
500	116				116
600	116				116
700	116				116
800	116				116
900	116				116
1000	116				116
1100	116				116
1200	116				116
1300	116				116
1400	116				116
1500	116				116
1600	116	668		700	116
1700	116	734		734	116
1800	116	768		800	116
1900	116	834		834	116
2000	116	868		900	116
2100	116	934		934	116
2200	116	968		1000	116
2300	116	1034		1034	116
2400	116	734	700	734	116
2500	116	767	734	767	116
2600	116	767	834	767	116
2700	116	834	800	834	116
2800	116	867	834	867	116
2900	116	900	868	900	116
3000	116	934	900	934	116

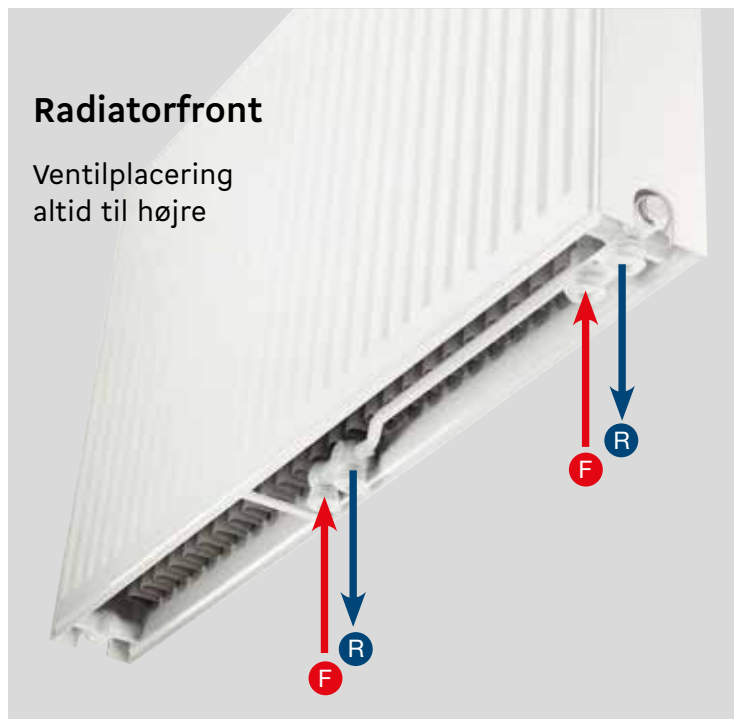

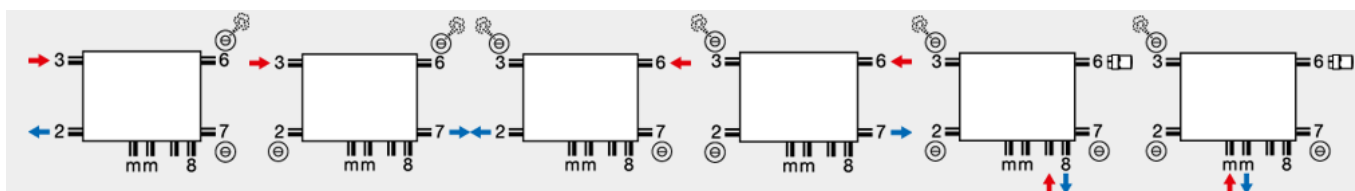

Super8 højde 300 mm

Type	VVS-Nr.	Ydelse 70/40/20	Ydelse 60/40/20	Ydelse 45/35/20	Vægt
11-300-500*	32.8731.535	152	129	78	6,09
11-300-600*	32.8731.536	182	155	93	6,97
11-300-800*	32.8731.538	243	206	124	8,73
11-300-1000*	32.8731.540	304	258	156	10,5
11-300-1200*	32.8731.542	364	309	187	12,25
11-300-1400*	32.8731.544	425	361	218	14,01
11-300-1600*	32.8731.546	486	412	249	16,00
11-300-1800*	32.8731.548	546	464	280	17,76
11-300-2000*	32.8731.550	607	515	311	19,51
11-300-2200*	32.8731.552	668	567	342	21,28
11-300-2400*	32.8731.554	728	618	373	23,28
11-300-2800*	32.8731.558	850	721	435	26,78
21-300-500*	32.8733.535	218	230	111	8,76
21-300-1000*	32.8733.540	435	460	222	15,95
21-300-1400*	32.8733.544	610	645	311	21,66
21-300-2000*	32.8733.550	871	921	444	30,51
22-300-500*	32.8734.535	272	230	138	9,73
22-300-600*	32.8734.536	326	276	166	11,34
22-300-800*	32.8734.538	435	368	222	14,57
22-300-1000*	32.8734.540	543	460	277	17,87
22-300-1200*	32.8734.542	652	553	332	21,10
22-300-1400*	32.8734.544	761	645	388	23,63
22-300-1600*	32.8734.546	869	737	443	27,85
22-300-1800*	32.8734.548	978	829	499	31,08
22-300-2000*	32.8734.550	1087	921	554	34,31
22-300-2200*	32.8734.552	1195	1013	609	37,54
22-300-2400*	32.8734.554	1304	1105	665	41,07
22-300-2600*	32.8734.556	1413	1197	720	44,30
22-300-2800*	32.8734.558	1521	1289	776	47,53
22-300-3000*	32.8734.560	1630	1381	831	50,76
33-300-800*	32.8736.538	621	527	320	19,90
33-300-1000*	32.8736.540	776	659	400	24,87
33-300-1200*	32.8736.542	931	791	480	29,84
33-300-1400*	32.8736.544	1086	923	560	34,82
33-300-1600*	32.8736.546	1241	1055	639	40,90
33-300-1800*	32.8736.548	1397	1187	719	45,71
33-300-2200*	32.8736.552	1707	1450	879	55,32
33-300-3000*	32.8736.560	2328	1978	1199	74,88

* Leveringstid 4-8 arbejdsdage

Super8 højde 400 mm

Type	VVS-nr.	Ydelse 70/40/20	Ydelse 60/40/20	Ydelse 45/35/20	Vægt
11-400-500*	32.8741.535	193	164	99	7,36
11-400-600*	32.8741.536	231	196	119	8,47
11-400-700*	32.8741.537	270	229	138	9,58
11-400-800*	32.8741.538	309	262	158	10,69
11-400-900*	32.8741.539	347	295	178	11,80
11-400-1000*	32.8741.540	386	327	198	12,92
11-400-1100*	32.8741.541	424	360	217	14,03
11-400-1200*	32.8741.542	463	393	237	15,14
11-400-1400*	32.8741.544	540	458	277	17,36
11-400-1600*	32.8741.546	617	524	316	19,82
11-400-1800*	32.8741.548	694	589	356	22,04
11-400-2000*	32.8741.550	772	655	395	24,26
11-400-2200*	32.8741.552	849	720	435	26,49
11-400-2400*	32.8741.554	926	786	474	28,96
11-400-2600*	32.8741.556	1003	851	514	31,17
11-400-2800*	32.8741.558	1080	916	553	33,40
11-400-3000*	32.8741.560	1157	982	593	35,63

21-400-500*	32.8743.535	275	233	140	11,08
21-400-600*	32.8743.536	330	279	168	12,97
21-400-700*	32.8743.537	385	326	196	14,86
21-400-800*	32.8743.538	440	373	224	16,75
21-400-900*	32.8743.539	495	419	252	18,64
21-400-1000*	32.8743.540	550	466	280	20,57
21-400-1200*	32.8743.542	660	559	336	24,35
21-400-1400*	32.8743.544	770	652	392	28,13
21-400-1600*	32.8743.546	879	745	448	32,19
21-400-1800*	32.8743.548	989	838	504	35,97
21-400-2000*	32.8743.550	1099	932	560	39,74
21-400-2200*	32.8743.552	1209	1025	616	43,52
21-400-2400*	32.8743.554	1319	1118	673	47,58
21-400-2600*	32.8743.556	1429	1211	729	51,36
21-400-2800*	32.8743.558	1539	1304	785	55,14
21-400-3000*	32.8743.560	1649	1397	841	58,92

22-400-500*	32.8744.535	345	292	175	12,97
22-400-600*	32.8744.536	414	351	210	15,13
22-400-700*	32.8744.537	483	409	245	17,29
22-400-800*	32.8744.538	552	467	280	19,45
22-400-900*	32.8744.539	621	526	315	21,61
22-400-1000*	32.8744.540	690	584	350	23,83
22-400-1100*	32.8744.541	759	643	385	25,99
22-400-1200*	32.8744.542	828	701	420	28,15
22-400-1400*	32.8744.544	967	818	490	31,77
22-400-1600*	32.8744.546	1105	935	560	37,08
22-400-1800*	32.8744.548	1243	1052	630	41,40
22-400-2000*	32.8744.550	1381	1169	700	45,72
22-400-2200*	32.8744.552	1519	1286	770	50,04
22-400-2400*	32.8744.554	1657	1402	840	54,65
22-400-2600*	32.8744.556	1795	1519	910	58,97
22-400-2800*	32.8744.558	1933	1636	980	63,29
22-400-3000*	32.8744.560	2071	1753	1050	67,61

33-400-600*	32.8746.536	591	501	303	21,34
33-400-800*	32.8746.538	788	668	404	27,78
33-400-1000*	32.8746.540	985	835	505	34,32
33-400-1200*	32.8746.542	1182	1003	605	40,76
33-400-1400*	32.8746.544	1379	1170	706	46,26
33-400-1600*	32.8746.546	1575	1337	807	53,98
33-400-1800*	32.8746.548	1772	1504	908	60,42
33-400-2000*	32.8746.550	1969	1671	1009	66,86
33-400-2200*	32.8746.552	2166	1838	1110	73,30
33-400-3000*	32.8746.560	2954	2506	1514	99,40

* Leveringstid 4-8 arbejdsdage

Super8 højde 500 mm

Type	VVS-nr.	Ydelse 70/40/20	Ydelse 60/40/20	Ydelse 45/35/20	Vægt
11-500-400*	32.8751534	186	158	95	7,42
11-500-500*	32.8751.535	232	197	119	8,79
11-500-600*	32.8751.536	279	236	143	10,16
11-500-700*	32.8751.537	325	276	167	11,53
11-500-800*	32.8751.538	372	315	190	12,90
11-500-900*	32.8751.539	418	355	214	14,27
11-500-1000*	32.8751.540	465	394	238	15,65
11-500-1100*	32.8751.541	511	434	262	17,03
11-500-1200*	32.8751.542	557	473	28	18,40
11-500-1400*	32.8751.544	650	552	333	21,14
11-500-1600*	32.8751.546	743	631	381	24,12
11-500-1800*	32.8751.548	836	709	428	26,86
11-500-2000*	32.8751.550	929	788	476	29,60
11-500-2200*	32.8751.552	1022	867	524	32,35
11-500-2400*	32.8751.554	1115	946	571	35,34
11-500-2600*	32.8751.556	1208	1025	619	38,07
11-500-2800*	32.8751.558	1301	1104	667	40,82

21-500-500*	32.8753.535	32,8	277	166	13,31
21-500-600*	32.8753.536	393	333	199	15,64
21-500-700*	32.8753.537	459	388	233	17,97
21-500-800*	32.8753.538	524	444	266	20,30
21-500-900*	32.8753.539	590	499	299	22,62
21-500-1000*	32.8753.540	655	555	332	24,99
21-500-1100*	32.8753.541	721	610	366	27,32
21-500-1200*	32.8753.542	786	666	399	29,65
21-500-1400*	32.8753.544	918	777	465	34,30
21-500-1600*	32.8753.546	1049	887	532	39,24
21-500-1800*	32.8753.548	1180	998	598	43,89
21-500-2000*	32.8753.550	1311	1109	665	48,55
21-500-2200*	32.8753.552	1442	1220	731	53,20
21-500-2400*	32.8753.554	1573	1331	798	58,13
21-500-2600*	32.8753.556	1704	1442	864	62,79
21-500-2800*	32.8753.558	1835	1553	931	67,44

22-500-400	32.8754.534	333	282	169	12,34
22-500-500*	32.8754.535	416	352	211	15,02
22-500-600	32.8754.536	499	423	253	17,69
22-500-700*	32.8754.537	583	493	295	20,37
22-500-800	32.8754.538	666	564	338	23,05
22-500-900*	32.8754.539	749	634	380	25,73
22-500-1000	32.8754.540	832	704	422	28,47
22-500-1100*	32.8754.541	915	775	464	31,14
22-500-1200	32.8754.542	999	845	507	33,82
22-500-1400*	32.8754.544	1165	986	591	38,48
22-500-1600*	32.8754.546	1332	1127	675	44,83
22-500-1800*	32.8754.548	1498	1268	760	50,18
22-500-2000*	32.8754.550	1665	1409	844	55,54
22-500-2200*	32.8754.552	1831	1550	929	60,89
22-500-2400*	32.8754.554	1997	1691	1013	66,54
22-500-2600*	32.8754.556	2164	1831	1097	71,89
22-500-2800*	32.8754.558	2330	1972	1182	77,25
22-500-3000*	32.8754.560	2497	2113	1266	82,60

33-500-500*	32.8756.535	591	501	301	22,05
33-500-600*	32.8756.536	709	601	361	26,04
33-500-700*	32.8756.537	827	701	422	30,04
33-500-800*	32.8756.538	945	801	482	34,03
33-500-1000*	32.8756.540	1181	1001	602	42,13
33-500-1100*	32.8756.541	1299	1101	662	46,12
33-500-1200*	32.8756.542	1418	1201	723	50,12
33-500-1400*	32.8756.544	1654	1401	843	57,17
33-500-1600*	32.8756.546	1890	1602	964	66,43
33-500-1800*	32.8756.548	2126	1802	1084	74,42
33-500-2400*	32.8756.554	2835	2402	1445	98,73

* Leveringstid 4-8 arbejdsdage

Super8 højde 600 mm

Type	VVS-nr.	Ydelse 70/40/20	Ydelse 60/40/20	Ydelse 45/35/20	Vægt
11-600-500*	32.8761.535	270	230	139	10,46
11-600-600*	32.8761.536	325	275	166	12,17
11-600-700*	32.8761.537	379	321	194	13,87
11-600-800*	32.8761.538	433	367	222	15,58
11-600-900*	32.8761.539	487	413	249	17,29
11-600-1000*	32.8761.540	541	459	277	19,00
11-600-1100*	32.8761.541	595	505	305	20,71
11-600-1200*	32.8761.542	649	551	333	22,42
11-600-1400*	32.8761.544	757	643	388	25,83
11-600-1600*	32.8761.546	866	734	444	29,48
11-600-1800*	32.8761.548	974	826	499	32,90
11-600-2000*	32.8761.550	1082	918	554	36,31
11-600-2200*	32.8761.552	1190	1010	610	39,73
11-600-2400*	32.8761.554	1298	1102	665	43,39
11-600-2600*	32.8761.556	1407	1193	721	46,80
11-600-3000*	32.8761.560	1623	1377	832	53,64
20-600-600*	32.8681.636	357	303	183	26,10
20-600-800*	32.8681.638	475	403	244	17,01
21-600-500*	32.8763.535	380	321	193	15,97
21-600-600*	32.8763.536	456	386	231	18,80
21-600-700*	32.8763.537	532	450	270	21,64
21-600-800*	32.8763.538	607	514	308	24,47
21-600-900*	32.8763.539	683	578	347	27,30
21-600-1000*	32.8763.540	759	643	385	30,17
21-600-1100*	32.8763.541	835	707	424	33,01
21-600-1200*	32.8763.542	911	771	462	35,84
21-600-1400*	32.8763.544	1063	900	539	41,50
21-600-1600*	32.8763.546	1215	1028	616	47,44
21-600-1800*	32.8763.548	1367	1157	693	53,11
22-600-500*	32.8764.535	481	407	243	18,65
22-600-600	32.8764.536	578	488	291	21,92
22-600-700*	32.8764.537	674	570	340	25,19
22-600-800	32.8764.538	770	651	389	28,46
22-600-900*	32.8764.539	770	732	437	31,73
22-600-1000	32.8764.540	963	814	486	35,06
22-600-1100	32.8764.541	1059	895	534	38,33
22-600-1200	32.8764.542	1155	976	583	41,60
22-600-1400*	32.8764.544	1348	1139	680	47,45
22-600-1600*	32.8764.546	1539	1302	777	55,24
22-600-1800*	32.8764.548	1733	1465	874	61,78
22-600-2000*	32.8764.550	1925	1627	971	68,31
22-600-2200*	32.8764.552	2118	1790	1069	74,85
22-600-2400*	32.8764.554	2310	1953	1166	81,95
22-600-2600*	32.8764.556	2503	2116	1263	88,46
22-600-2800*	32.8764.558	2695	2278	1360	95,03
22-600-3000*	32.8764.560	2888	2441	1457	101,8
33-600-500*	32.8766.535	683	578	347	26,70
33-600-600*	32.8766.536	820	694	416	31,59
33-600-800*	32.8766.538	1093	925	554	41,35
33-600-1000*	32.8766.540	1366	1156	693	51,22
33-600-1200	32.8766.542	1640	1388	832	60,99
33-600-1400*	32.8766.544	1913	1619	970	69,82
33-600-1600*	32.8766.546	2186	1850	1109	80,86

* Leveringstid 4-8 arbejdsdage

Super8 højde 700 mm

Type	VVS-nr.	Ydelse 70/40/20	Ydelse 60/40/20	Ydelse 45/35/20	Vægt
11-700-400*	32.8771.534	246	209	126	9,95
11-700-500*	32.8771.535	308	261	158	11,89
11-700-600*	32.8771.536	369	313	189	13,84
11-700-800*	32.8771.538	493	418	252	17,74
11-700-1000*	32.8771.540	616	522	316	21,64
11-700-1200*	32.8771.542	739	627	379	25,53
11-700-1400*	32.8771.544	862	731	442	29,43
11-700-1600*	32.8771.546	985	836	505	33,56
21-700-500*	32.8773.535	430	364	218	18,23
21-700-600*	32.8773.536	517	437	262	21,53
21-700-800*	32.8773.538	689	583	349	28,14
21-700-1000*	32.8773.540	861	729	437	34,79
21-700-1200*	32.8773.542	1033	874	524	41,40
21-700-1400*	32.8773.544	1205	1020	539	48,01
22-700-400*	32.8774.534	436	369	220	16,89
22-700-500*	32.8774.535	545	461	275	20,71
22-700-600*	32.8774.536	654	553	330	24,54
22-700-700*	32.8774.537	764	645	385	28,36
22-700-800*	32.8774.538	873	738	440	32,19
22-700-900*	32.8774.539	982	830	495	36,02
22-700-1000*	32.8774.540	1091	922	550	39,88
22-700-1200*	32.8774.542	1309	1106	660	47,53
22-700-1400*	32.8774.544	1527	1291	771	54,49
22-700-1600*	32.8774.546	1745	1475	881	63,11
33-700-500*	32.8776.535	771	652	389	30,75
33-700-600*	32.8776.536	925	782	467	36,47
33-700-800*	32.8776.538	1234	1043	622	47,90
33-700-1000*	32.8776.540	1542	1303	778	59,44

















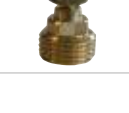

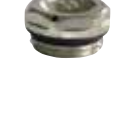



* Leveringstid 4-8 arbejdsdage

Super8 højde 900 mm

Type	VVS-nr.	Ydelse 70/40/20	Ydelse 60/40/20	Ydelse 45/35/20	Vægt
11-900-400*	32.8791.534	304	258	156	12,63
11-900-500*	32.8791.535	380	322	195	15,14
11-900-600*	32.8791.536	456	387	234	17,64
11-900-700*	32.8791.537	532	451	273	20,14
11-900-800*	32.8791.538	608	516	312	22,65
11-900-900*	32.8791.539	684	580	350	25,15
11-900-1000*	32.8791.540	760	645	389	27,66
11-900-1200*	32.8791.542	912	774	467	32,67
11-900-1400*	32.8791.544	1064	903	545	37,68
20-900-500*	32.8593.635	413	349	209	21,67
20-900-600*	32.8593.636	495	419	251	22,71
21-900-500*	32.8793.535	526	445	266	23,02
21-900-600*	32.8793.536	632	534	319	27,27
21-900-700*	32.8793.537	737	623	372	31,52
21-900-800*	32.8793.538	842	712	425	35,76
21-900-900*	32.8793.539	948	801	478	40,01
21-900-1000*	32.8793.540	1053	890	531	44,30
22-900-400*	32.8794.534	530	447	266	20,79
22-900-500*	32.8794.535	662	559	333	25,72
22-900-600*	32.8794.536	795	671	399	30,66
22-900-700*	32.8794.537	927	783	466	35,60
22-900-800*	32.8794.538	1060	895	532	40,53
22-900-900*	32.8794.539	1192	1007	599	45,47
22-900-1000*	32.8794.540	1325	1118	665	50,47
22-900-1200*	32.8794.542	1590	1342	798	60,34
33-900-400*	32.8796.534	751	634	377	31,63
33-900-500*	32.8796.535	939	793	471	39,01
33-900-600*	32.8796.536	1127	951	566	46,39
33-900-700*	32.8796.537	1315	1110	660	53,78
33-900-800*	32.8796.538	1502	1268	754	61,16
33-900-900*	32.8796.539	1690	1427	848	68,54
33-900-1200*	32.8796.542	2253	1902	1131	90,78

* Leveringstid 4-8 arbejdsdage

Ekstra tilbehør Super8

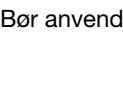
	Type	VVS-nr.			
	THERMRAD FJEDERKONSOL HØJDE 300 MM	32.2244.103		H-BLOK KRYDS 3/4" VINKEL	40.3301.506*
	THERMRAD FJEDERKONSOL HØJDE 400 MM	32.2244.104		THERMRAD 1 STRENGS H-BLOK 3/4"	40.3300.306*
	THERMRAD FJEDERKONSOL HØJDE 500 MM	32.2244.105		OMLØBER TIL THERMRAD H-BLOK 15 MM PEX	40.2179.415
	THERMRAD FJEDERKONSOL HØJDE 600 MM	32.2244.106		OMLØBER TIL THERMRAD H-BLOK 16 MM ALUPEX	40.2179.317
	THERMRAD FJEDERKONSOL HØJDE 700 MM	32.2244.107		DANFOSS OMLØBERSÆT 3/4 X 15MM	45.1271.055
	THERMRAD FJEDERKONSOL HØJDE 900 MM	32.2244.109		DOBBELTROSET C/C 50 MM TIL RØR 14-20 MM	40.2179.850
					TILSLUTNINGSRØR 1/2" X 15MM X 150MM
	SOLAR PLUS GULVBEN LAV MODEL TIL TYPE 22 OG 33 MÅL HØJDE 130-200 MM	32.1044.100		VSH KLEMRING 15MM STÅL/CUX 3/4" EURO TIL TILSL.RØR 40.2179.515	40.2179.315
	SOLAR PLUS GULVBEN HØJ MODEL TIL TYPE 22 OG 33	32.1044.101		1/2" LUFTSKRUE MESSING	40.5501.104
	THERMRAD S8 GULVBEN LAV MODEL T TYPE 21	32.1044.103		1/2" LUFTSKRUE MED O-RING FORKROMET	40.5524.004
	THERMRAD GULVROSET TIL KONVEKTORBEN	32.1044.110		1/2" RADIATORPROP MED O-RING	40.5494.004
	DANFOSS VENTILINDSATS TIL SUPER8 CENTRALVARME	40.8700.200		NØGLE TIL LUFTSKRUE	40.5516.000
	DANFOSS VENTILINDSATS TIL SUPER8 TIL FJERNVARME	40.8701.200		UNIVERSAL LUFTSKRUE-NØGLE 4-VEJS	40.5719.000
	FØLERELEMENT M30 HVID STANDARD UNI LH	40.3431.013		1/2 BUNDHANE N/N MED SLUTMUFFE	40.7105.004
	FØLERELEMENT UNI LD PASSES TIL DANFOSS RADIATOR	40.3431.030		RADIATORFORSKRUNING LIGEL. 3/8	40.5000.003
	SOLAR PLUS H-BLOK 3/4" LIGE	40.3300.006*		RADIATORFORSKRUNING LIGEL. 1/2	40.5000.004
	SOLAR PLUS H-BLOK 3/4" VINKEL	40.3301.006*		RADIATORFORSKRUNING VINKEL 3/8	40.5001.003
	THERMRAD TELESKOP H-BLOK 3/4" LIGE	40.3300.206*		RADIATORFORSKRUNING VINKEL 1/2	40.5001.004
	TELESKOP H-BLOK 3/4" VINKEL	40.3301.206*		PÅFYLDNINGSSLANGE CENTRALVARME. 3,5M.	37.1103.002
	H-BLOK KRYDS 3/4" LIGE	40.3300.506*			

*Bør anvendes ved montering af Super8

Super8 Plan

Thermrad Super8 Plan er en klassisk panelradiator, som leveres med toprist, sidepanel og påmonteret plan front.

Super8 leveres med integreret ventilsystem, som muliggør tilslutning nedefra.

Ventil skal altid placeres i højre side top ved anvendelse af bundanboringer.

Super8 Plan er forsynet med 8 anboringer.



Tekniske data

Konstruktion	Iht. EN442-1
Materiale	Koldvalset stålplade iht. EN 10130
Overfladebehandling	Overfladebehandling i fem faser: <ul style="list-style-type: none">· Alkalisk affedtning· Fosfatering· Rustbeskyttende grundmaling· Polyester-epoxy pulverlakering· Pulverlakering brændt ved 210 grader
Farve	RAL 9016
Driftstryk	10 bar
Anboring	4 x 1/2" hjørneanboringer, anboringer iht. ISO 228 og 4x3/4" eurokonus bundanboringer.
Højder	300 – 400 – 500 – 600 - 700 og 900 mm
Typer	Type 11 – enkeltplade med en konvektionslamel Type 21 – dobbeltplade med en konvektionslamel Type 22 – dobbeltplade med to konvektionslameller Type 33 – tredobbeltplade med tre konvektionslameller
Garanti	Der ydes 10 års garanti på defekter forårsaget af materiale- eller produktionsfejl.
Medleveret tilbehør	Leveres med bæringer inkl. skuer og plugs, luftskrue, blindprop og aftapsventil og ventil M30.

Super8 Plan

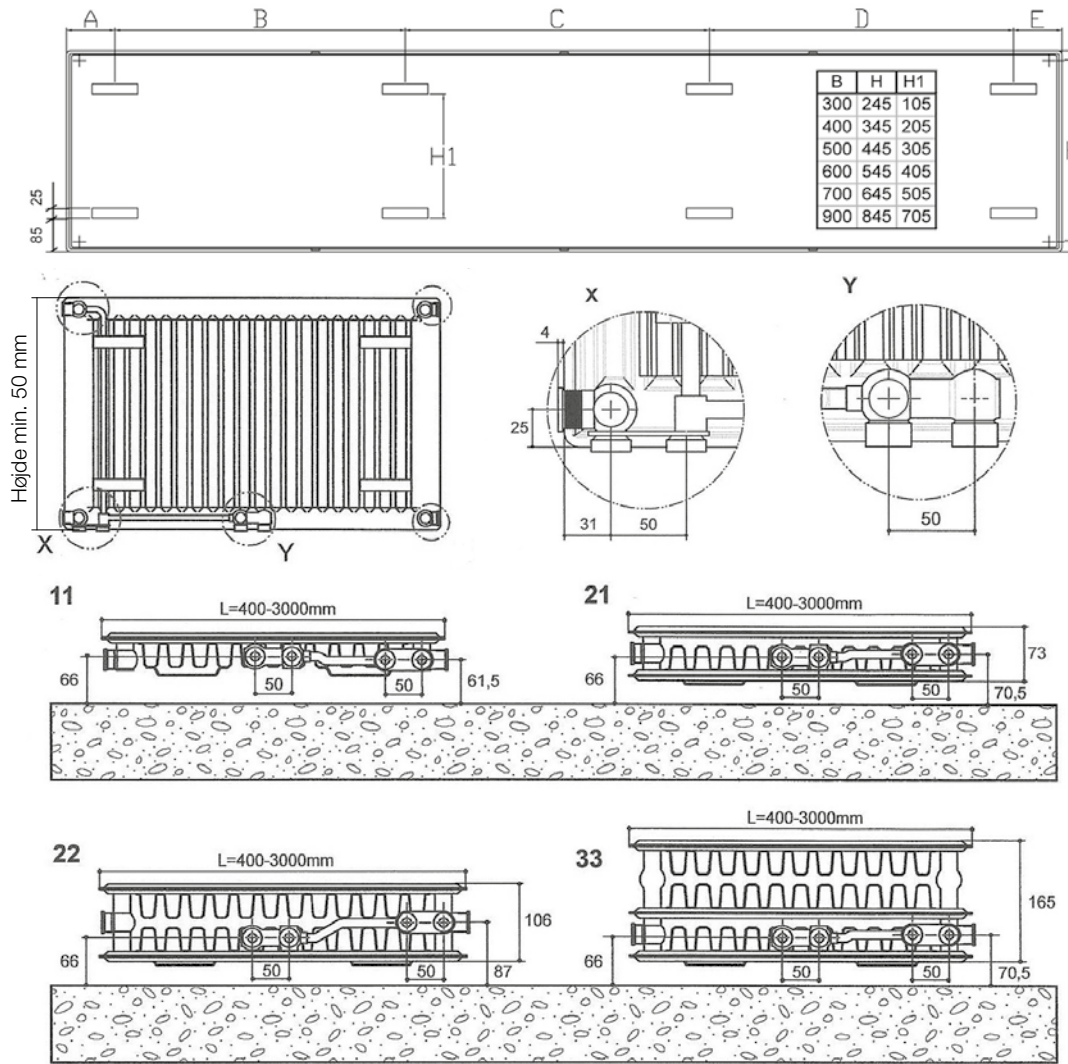

Konsolplacering

Længde radiator	A	B	C	D	E
400	116				116
500	116				116
600	116				116
700	116				116
800	116				116
900	116				116
1000	116				116
1100	116				116
1200	116				116
1300	116				116
1400	116				116
1500	116				116
1600	116	668		700	116
1700	116	734		734	116
1800	116	768		800	116
1900	116	834		834	116
2000	116	868		900	116
2100	116	934		934	116
2200	116	968		1000	116
2300	116	1034		1034	116
2400	116	734	700	734	116
2500	116	767	734	767	116
2600	116	767	834	767	116
2700	116	834	800	834	116
2800	116	867	834	867	116
2900	116	900	868	900	116
3000	116	934	900	934	116

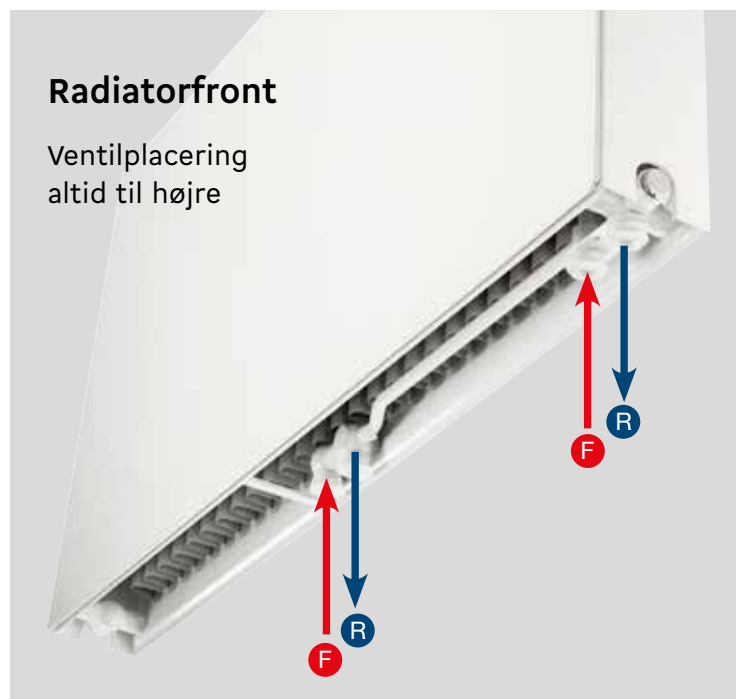

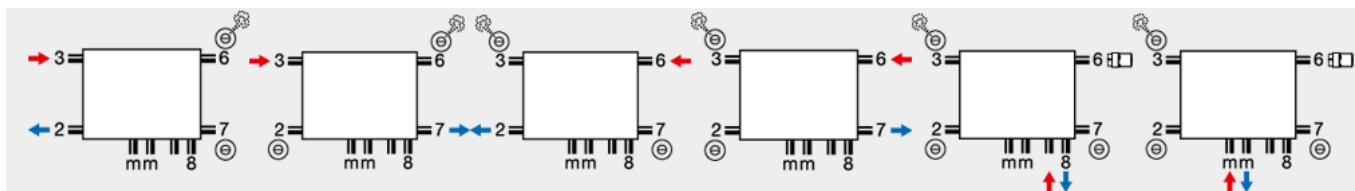

Super8 Plan højde 300 mm

Type	VVS-nr.	Ydelse 70/40/20	Ydelse 60/40/20	Ydelse 45/35/20	Vægt
21-300-500*	32.8553.535	197	167	100	8,23
21-300-1000*	32.8553.540	394	333	200	16,45
21-300-1400*	32.8553.544	552	467	280	23,03
21-300-2000*	32.8553.550	788	667	400	32,90
22-300-600*	32.8554.536	301	255	153	12,30
22-300-800*	32.8554.538	402	340	204	16,40
22-300-1000*	32.8554.540	503	425	255	20,51
22-300-1200*	32.8554.542	603	510	306	24,26
22-300-1400*	32.8554.544	704	596	357	28,01
22-300-1600*	32.8554.546	804	681	408	32,06
22-300-1800*	32.8554.548	905	766	459	35,81
22-300-2000*	32.8554.550	1005	851	510	39,57
22-300-2400*	32.8554.554	1206	1021	612	41,10
22-300-2800*	32.8554.558	1407	1191	714	54,87
33-300-1000*	32.8556.540	713	604	363	27,70
33-300-1200*	32.8556.542	855	725	436	32,90
33-300-1400*	32.8556.544	998	846	509	38,10

* Leveringstid 4-8 arbejdsdage

Super8 Plan højde 400 mm

Type	VVS-nr.	Ydelse 70/40/20	Ydelse 60/40/20	Ydelse 45/35/20	Vægt
11-400-500*	32.8561.535	156	132	80	9,15
11-400-600*	32.8561.536	187	159	96	10,61
11-400-800*	32.8561.538	250	212	128	13,53
11-400-1000*	32.8561.540	312	265	160	16,47
11-400-1200*	32.8561.542	375	318	192	19,39
11-400-1400*	32.8561.544	437	371	224	22,32
11-400-1600*	32.8561.546	500	424	256	25,48
11-400-1800*	32.8561.548	562	477	288	28,41
11-400-2000*	32.8561.550	624	530	320	31,33
21-400-800*	32.8563.538	399	338	203	19,59
21-400-1000*	32.8563.540	499	423	254	24,12
21-400-1200*	32.8563.542	599	507	305	28,60
21-400-1400*	32.8563.544	698	592	356	33,09
21-400-1600*	32.8563.546	798	676	407	37,85
21-400-2000*	32.8563.550	998	846	508	48,20
22-400-500*	32.8564.535	316	268	160	13,65
22-400-600*	32.8564.536	379	321	192	16,38
22-400-800*	32.8564.538	506	428	257	22,29
22-400-900*	32.8564.539	569	482	289	24,80
22-400-1000*	32.8564.540	632	535	321	27,38
22-400-1200*	32.8564.542	759	642	385	32,40
22-400-1400*	32.8564.544	885	749	449	37,42
22-400-1600*	32.8564.546	1012	856	513	42,74
22-400-1800*	32.8564.548	1138	963	577	47,76
22-400-2000*	32.8564.550	1265	1070	641	52,79
22-400-2200*	32.8564.552	1391	1177	706	50,07
22-400-2400*	32.8564.554	1518	1285	770	63,13
22-400-2600*	32.8564.556	1644	1392	834	59,02
22-400-2800*	32.8564.558	1771	1499	898	73,17
33-400-2000	32.8566.550	1767	1498	901	71,80

* Leveringstid 4-8 arbejdsdage

Super8 Plan højde 500 mm

Type	VVS-nr.	Ydelse70/40/20	Ydelse60/40/20	Ydelse45/35/20	Vægt
11-500-500*	32.8571.535	188	159	96	10,98
11-500-600*	32.8571.536	226	191	116	12,79
11-500-800*	32.8571.538	301	255	154	16,39
11-500-1000*	32.8571.540	376	319	193	20,01
11-500-1200*	32.8571.542	451	383	231	23,62
11-500-1400*	32.8571.544	526	447	270	27,23
11-500-1600*	32.8571.546	601	510	308	31,07
11-500-1800*	32.8571.548	676	574	347	36,00
11-500-2000*	32.8571.560	752	638	386	40,00
21-500-600*	32.8573.536	358	304	184	17,58
21-500-800*	32.8573.538	478	406	245	20,24
21-500-1000*	32.8573.540	598	508	307	29,35
21-500-1200*	32.8573.542	718	609	368	34,87
21-500-1400*	32.8573.544	838	711	429	40,39
21-500-1600*	32.8573.546	957	812	491	46,19
21-500-2000*	32.8573.550	1197	1015	613	57,23
22-500-400*	32.8574.534	302	255	153	13,12
22-500-500*	32.8574.535	377	319	191	17,21
22-500-600*	32.8574.536	453	383	230	20,32
22-500-700*	32.8574.537	528	447	268	23,43
22-500-800	32.8574.538	604	511	306	26,54
22-500-900	32.8574.539	679	575	345	29,65
22-500-1000	32.8574.540	755	639	383	32,82
22-500-1200	32.8574.542	906	767	459	39,04
22-500-1400*	32.8574.544	1057	894	536	45,26
22-500-1600*	32.8574.546	1208	1022	612	51,78
22-500-1800*	32.8574.548	1359	1150	689	58,00
22-500-2000*	32.8574.550	1509	1278	766	64,22
22-500-2200*	32.8574.552	1660	1404	842	60,92
22-500-2400*	32.8574.554	1811	1533	919	66,57
22-500-3000*	32.8574.560	2265	1917	1149	98,40
33-500-700*	32.8576.537	733	620	372	32,90
33-500-800*	32.8576.538	837	709	425	37,30
33-500-1000*	32.8576.540	1046	885	530	46,60
33-500-1200*	32.8576.542	1256	1063	637	54,40

* Leveringstid 4-8 arbejdsdage

Super8 Plan højde 600 mm

Type	VVS-nr.	Ydelse 70/40/20	Ydelse 60/40/20	Ydelse 45/35/20	Vægt
11-600-500*	32.8581.535	227	193	116	13,05
11-600-600*	32.8581.536	272	231	140	15,26
11-600-700*	32.8581.537	317	269	163	16,87
11-600-800*	32.8581.538	363	308	186	19,70
11-600-1000*	32.8581.540	454	385	233	24,15
11-600-1200*	32.8581.542	545	462	279	28,58
11-600-1400*	32.8581.544	636	539	326	33,02
11-600-1600*	32.8581.546	727	616	372	37,69
21-600-600*	32.8583.536	409	346	207	21,90
21-600-800*	32.8583.538	545	462	277	28,59
21-600-1000*	32.8583.540	682	577	346	35,32
21-600-1200*	32.8583.542	818	692	415	42,00
21-600-1400*	32.8583.544	954	808	484	48,69
21-600-1800*	32.8583.548	1227	1038	277	63,54
22-600-500*	32.8584.535	433	366	219	20,54
22-600-600*	32.8545.536	520	439	262	24,32
22-600-700*	32.8584.537	607	439	262	27,65
22-600-800*	32.8584.538	693	586	350	31,88
22-600-900	32.8584.539	780	659	394	35,66
22-600-1000	32.8584.540	867	732	437	39,50
22-600-1200	32.8584.542	1040	879	525	47,06
22-600-1400	32.8584.544	1213	1025	612	54,62
22-600-1600	32.8584.546	1386	1172	700	62,48
22-600-1800*	32.8584.548	1560	1318	787	70,04
22-600-2000*	32.8584.550	1733	1465	874	77,61
22-600-2200*	32.8584.552	1907	1610	961	86,90
33-600-600*	32.8586.536	727	615	369	34,40
33-600-800*	32.8586.538	970	821	492	45,00
33-600-1000*	32.8586.540	1212	1026	615	55,60
33-600-1200*	32.8586.542	1454	1231	738	66,20

* Leveringstid 4-8 arbejdsdage

Super8 Plan højde 700 mm

Type	VVS-nr.	Ydelse70/40/20	Ydelse60/40/20	Ydelse45/35/20	Vægt
11-700-400*	32.8582.534	199	106	102	12,80
11-700-500*	32.8582.535	249	212	128	15,20
11-700-600*	32.8582.536	299	254	153	17,90
11-700-800*	32.8582.538	399	339	204	22,90
11-700-1000*	32.8582.540	499	423	256	23,90
22-700-400*	32.8592.534	391	330	197	20,20
22-700-500*	32.8592.535	488	413	246	24,50
22-700-600*	32.8592.536	586	495	296	28,80
22-700-700*	32.8592.537	683	578	345	33,20
22-700-800*	32.8592.538	782	661	394	37,70
22-700-900*	32.8592.539	879	738	443	42,00
22-700-1000*	32.8592.540	977	826	493	46,30
22-700-1200*	32.8592.542	1172	991	591	47,60

* Leveringstid 4-8 arbejdsdage

Super8 Plan højde 900 mm

Type	VVS-nr.	Ydelse 70/40/20	Ydelse 60/40/20	Ydelse 45/35/20	Vægt
11-900-400*	32.8591.534	246	209	126	18,69
11-900-500*	32.8591.535	308	261	158	22,90
11-900-600*	32.8591.536	369	313	189	26,96
11-900-800*	32.8591.538	493	418	252	35,06
21-900-500*	32.8593.535	461	390	233	26,92
21-900-600*	32.8593.536	553	468	279	31,94
21-900-800*	32.8593.538	738	623	372	41,98
22-900-400*	32.8594.534	474	401	239	23,91
22-900-500*	32.8594.535	592	501	299	29,62
22-900-600*	32.8594.536	711	601	359	35,33
22-900-700*	32.8594.537	829	701	418	41,04
22-900-800*	32.8594.538	948	801	478	46,75
22-900-900*	32.8594.539		901	538	52,38
22-900-1000*	32.8594.540	1185	1001	598	58,24
33-900-400*	32.8596.534	687	582	349	24,20
33-900-500*	32.8596.535	859	727	436	30,30
33-900-600*	32.8596.536	1031	873	523	36,40
33-900-800*	32.8596.538	1375	1164	697	48,50

* Leveringstid 4-8 arbejdsdage

Ekstra tilbehør super8 plan

	Type	VVS-nr.		Type	VVS-nr.
	THERMRAD FJEDERKONSOL HØJDE 300 MM	32.2244.103		OMLØBER TIL THERMRAD H-BLOK 15 MM PEX	40.2179.415
	THERMRAD FJEDERKONSOL HØJDE 400 MM	32.2244.104		OMLØBER TIL THERMRAD H-BLOK 16 MM ALUPEX	40.2179.317
	THERMRAD FJEDERKONSOL HØJDE 500 MM	32.2244.105		DANFOSS OMLØBERSÆT 3/4 X 15MM	45.1271.055
	THERMRAD FJEDERKONSOL HØJDE 600 MM	32.2244.106		DOBBELTROSET C/C 50 MM TIL RØR 14-20 MM	40.2179.850
	THERMRAD FJEDERKONSOL HØJDE 700 MM	32.2244.107		TILSLUTNINGSRØR 1/2" X 15MMX150MM	40.2179.515
	THERMRAD FJEDERKONSOL HØJDE 900 MM	32.2244.109		VSH KLEMRING 15MM STÅL/CUX 3/4" EURO TIL TILSL.RØR 40.2179.515	40.2179.315
	SOLAR PLUS GULVBEN LAV MODEL TIL TYPE 22 OG 33 MÅL HØJDE 130-200 MM	32.1044.100		1/2" LUFTSKRUE MESSING	40.5501.104
	SOLAR PLUS GULVBEN HØJ MODEL TIL TYPE 22 OG 33	32.1044.101		1/2" LUFTSKRUE MED O-RING FORKROMET	40.5524.004
	THERMRAD S8 GULVBEN LAV MODEL T TYPE 21	32.1044.103		1/2" RADIATORPROP MED O-RING	40.5494.004
	THERMRAD GULVROSET TIL KONVEKTORBEN	32.1044.110		NØGLE TIL LUFTSKRUE	40.5516.000
	DANFOSS VENTILINDSATS TIL SUPER8 CENTRALVARME	40.8700.200		UNIVERSAL LUFTSKRUE-NØGLE 4-VEJS	40.5719.000
	DANFOSS VENTILINDSATS TIL SUPER8 TIL FJERNVARME	40.8701.200		1/2 BUNDHANE N/N M/SLUT-MUFFE	40.7105.004
	FØLERELEMENT M30 HVID STANDARD UNI LH	40.3431.013		RADIATORFORSKRUNING LIGEL. 3/8	40.5000.003
	FØLERELEMENT UNI LD PASSESER TIL DANFOSS RADIATOR	40.3431.030		RADIATORFORSKRUNING LIGEL. 1/2	40.5000.004
	SOLAR PLUS H-BLOK 3/4" LIGE	40.3300.006*		RADIATORFORSKRUNING VINKEL 3/8	40.5001.003
	SOLAR PLUS H-BLOK 3/4" VINKEL	40.3301.006*		RADIATORFORSKRUNING VINKEL 1/2	40.5001.004
	THERMRAD TELESKOP H-BLOK 3/4" LIGE	40.3300.206*		PÅFYLDNINGSSLANGE CENTRALVARME. 3,5M.	37.1103.002
	TELESKOP H-BLOK 3/4" VINKEL	40.3301.206*			
	H-BLOK KRYDS 3/4" LIGE	40.3300.506*			
	H-BLOK KRYDS 3/4" VINKEL	40.3301.506*			
	THERMRAD 1 STRENGS H-BLOK 3/4"	40.3300.306*			

*Bør anvendes ved montering af Super8

Super8 lavkonvektor

Thermrad Super8 lavkonvektor er en klassisk panelradiator, som leveres med toprist og sidepanel. Super8 lavkonvektor leveres med integreret ventilsystem. Ventilplacering valgfri, da radiator leveres uden bærebøjler og derfor er vendbar.

Super8 lavkonvektor er forsynet med 8 anboringer.

Super8 lavkonvektor er uden påsvejste bærebøjler.

Leveres uden fjederkonsol og ben, som bestilles separat.



Tekniske data

Konstruktion	Iht. EN442-1
Materiale	Koldvalset stålplade iht. EN 10130
Overfladebehandling	Overfladebehandling i fem faser: <ul style="list-style-type: none">· Alkalisk affedtning· Fosfatering· Rustbeskyttende grundmaling· Polyester-epoxy pulverlakering· Pulverlakering brændt ved 210 grader
Farve	RAL 9016
Driftstryk	10 bar
Anboring	4 x 1/2" hjørneanboringer, anboringer iht. ISO 228 og 4x3/4" eurokonus bundanboringer.
Højde	200 mm
Typer	Type 22 – dobbeltplade med to konvektionslameller Type 33 – tredobbeltplade med tre konvektionslameller
Garanti	Der ydes 10 års garanti på defekter forårsaget af materiale- eller produktionsfejl.
Medleveret tilbehør	Leveres med luftskruer, blindprop og aftapsventil og ventil M30.

Konvektor Super8 højde 200 mm

Type	VVS-nr.	Ydelse70/40/20	Ydelse60/40/20	Ydelse45/35/20	Vægt
22-200-800	32.8610.538	318	269	162	10,14
22-200-1000	32.8610.540	397	337	203	12,67
22-200-1200	32.8610.542	477	404	243	15,20
22-200-1400*	32.8610.544	556	472	284	17,74
22-200-1600	32.8610.546	636	539	324	20,27
22-200-1800	32.8610.548	715	606	365	22,81
22-200-2000	32.8610.550	795	674	405	25,34
22-200-2200*	32.8610.552	875	741	446	27,87
22-200-2400*	32.8610.554	955	808	486	30,24
22-200-2600*	32.8610.556	1035	876	527	32,76
22-200-2800*	32.8610.558	1115	943	567	35,28
22-200-3000*	32.8610.560	1195	1010	608	37,80
33-200-800	32.8611.538	452	383	232	15,68
33-200-1000*	32.8611.540	565	479	289	19,60
33-200-1200	32.8611.542	678	575	347	23,52
33-200-1400	32.8611.544	791	671	405	27,44
33-200-1600	32.8611.546	904	767	463	31,36
33-200-1800	32.8611.548	1017	863	521	35,28
33-200-2000	32.8611.550	1130	958	579	39,20
33-200-2200*	32.8611.552	1243	1054	637	43,12
33-200-2400*	32.8611.554	1355	1150	695	47,04
33-200-2600*	32.8611.556	1468	1246	753	50,96
33-200-2800*	32.8611.558	1581	1342	810	54,88
33-200-3000*	32.8611.560	1694	1438	868	58,80

* Leveringstid 4-8 arbejdsdage

Type 22

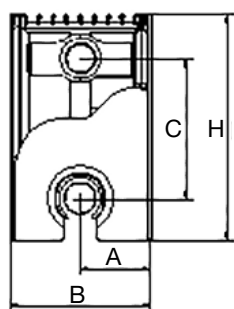

Type 33

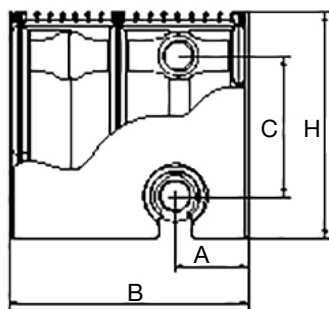

Højde/type	200	
	22	33
A*	49	49
B**	98	167
C	150	150
H	209	209

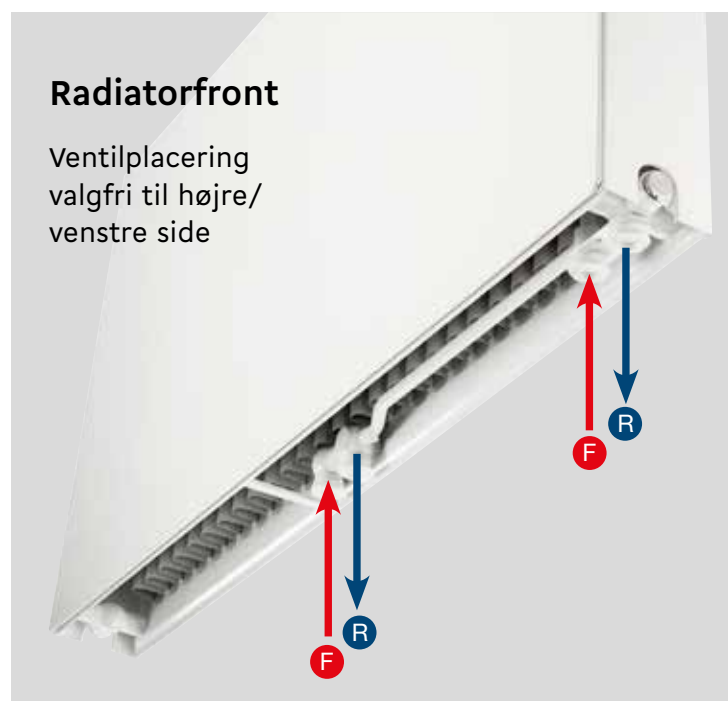

Radiatorfront

Ventilplacering
valgfri til højre/
venstre side

Konvektor Super8 Plan højde 200 mm

Thermrad Super8 lavkonvektor Plan er en klassisk panelradiator, som leveres med toprist og sidepanel og påmonteret plan front. Super8 lavkonvektor leveres med integreret ventilsystem.

Ventilplacering valgfri, da radiator leveres uden bærebøjler og derfor er vendbar.

Super8 lavkonvektor er forsynet med 8 anboringer.



Super8 lavkonvektor er uden påsvejste bærebøjler.

Leveres uden fjederkonsol og ben, som bestilles separat.

Type	VVS-nr.	Ydelse70/40/20	Ydelse60/40/20	Ydelse45/35/20	Vægt
22-200-800*	32.8612.538	296	251	151	11,14
22-200-1000*	32.8612.540	370	313	189	13,67
22-200-1200*	32.8612.542	444	376	226	16,40
22-200-1400*	32.8612.544	518	439	264	19,80
22-200-1600*	32.8612.546	592	501	302	22,10
22-200-1800*	32.8612.548	666	564	339	24,70
22-200-2000*	32.8612.550	740	627	377	27,60
22-200-2200*	32.8612.552	813	689	415	29,72
22-200-2400*	32.8612.554	887	752	452	32,20
22-200-2600*	32.8612.556	961	815	490	34,90
22-200-2800*	32.8612.558	1035	877	528	37,98
22-200-3000*	32.8612.560	1109	940	566	40,00
33-200-1000*	32.8613.540	569	483	292	20,90
33-200-1200*	32.8613.542	683	580	350	24,60
33-200-1400*	32.8613.544	797	676	409	28,80
33-200-1600*	32.8613.546	911	773	467	33,00
33-200-1800*	32.8613.548	1025	870	525	37,28
33-200-2000*	32.8613.550	1139	966	584	41,32
33-200-2200*	32.8613.552	1253	1063	642	45,14
33-200-2400*	32.8613.554	1367	1160	700	49,60
33-200-2600*	32.8613.556	1480	1256	759	53,20
33-200-2800*	32.8613.558	1594	1353	817	60,20

* Leveringstid 4-8 arbejdsdage

Ekstra tilbehør konvektor

	Type	VVS-nr.		Type	VVS-nr.
	THERMRAD FJEDERKONSOL HØJDE 200 MM	32.2244.102		TILSLUTNINGSRØR 1/2"X 15MMX150MM	40.2179.515
	SOLAR PLUS GULVBEN LAV MODEL TIL TYPE 22 OG 33 MÅL HØJDE 130-200 MM	32.1044.100		VSH KLEMRING 15MM STÅL/CUX 3/4"EURO TIL TILSL.RØR 40.2179.515	40.2179.315
	SOLAR PLUS GULVBEN HØJ MODEL TIL TYPE 22 OG 33	32.1044.101		1/2" LUFTSKRUE MESSING	40.5501.104
	THERMRAD GULVROSET TIL KONVEKTORBEN	32.1044.110		1/2" LUFTSKRUE MED O-RING FORKROMET	40.5524.004
	DANFOSS VENTILINDSATS TIL SUPER8	40.8700.200		1/2" RADIATORPROP MED O-RING	40.5494.004
	DANFOSS VENTILINDSATS TIL SUPER8 TIL FJERNVARME	40.8701.200		NØGLE TIL LUFTSKRUE	40.5516.000
	FØLERELEMENT M30 HVID STANDARD UNI LH	40.3431.013		UNIVERSAL LUFTSKRUE- NØGLE 4-VEJS	40.5719.000
	FØLERELEMENT UNI LD PAS- SER T. DANFOSS RADIATOR	40.3431.030		1/2 BUNDHANE N/N M/SLUTMUFFE	40.7105.004
	SOLAR PLUS H-BLOK 3/4" LIGE	40.3300.006*		RADIATORFORSKRUNING LIGEL. 3/8	40.5000.003
	SOLAR PLUS H-BLOK 3/4" VINKEL	40.3301.006*		RADIATORFORSKRUNING LIGEL. 1/2	40.5000.004
	THERMRAD TELESKOP H-BLOK 3/4" LIGE	40.3300.206*		RADIATORFORSKRUNING VINKEL 3/8	40.5001.003
	TELESKOP H-BLOK 3/4" VINKEL	40.3301.206*		RADIATORFORSKRUNING VINKEL 1/2	40.5001.004
	H-BLOK KRYDS 3/4" LIGE	40.3300.506*			
	H-BLOK KRYDS 3/4" VINKEL	40.3301.506*			
	THERMRAD 1 STRENGS H-BLOK 3/4"	40.3300.306*			
	OMLØBER TIL THERMRAD H-BLOK 15 MM PEX	40.2179.415			
	OMLØBER TIL THERMRAD H-BLOK 16 MM ALUPEX	40.2179.317			
	DANFOSS OMLØBERSÆT 3/4 X 15MM	45.1271.055			
	DOBBELTROSET C/C 50 MM TIL RØR 14-20 MM	40.2179.850			

Vertical

Thermrad Vertical dekorative radiatorer fås i 3 modeller

Vertical med profileret front.

Vertical Plan med påmonteret flad front.

Line Vertical med påmonteret flad front med tynd lodret profilering.

Alle Vertical radiatorer er forsynet med toprist og sideplader.

Bemærk, alle Vertical radiatorer skal tilsluttes i bunden.

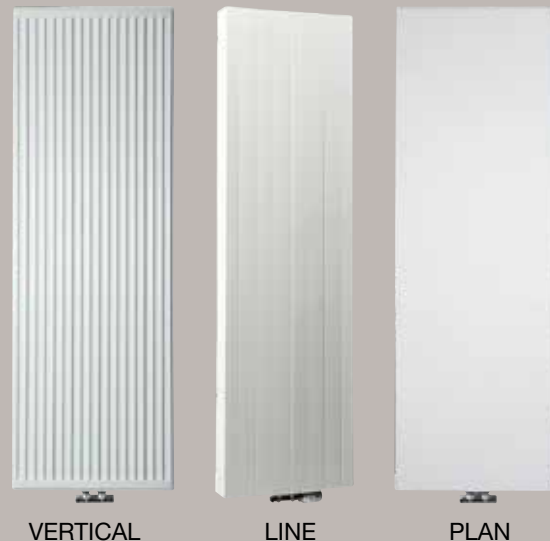

Tekniske data

Konstruktion	Iht. EN442-1
Materiale	Koldvalset stålplade iht. EN10130
Overfladebehandling	Overfladebehandling i fem faser: <ul style="list-style-type: none">· Alkalisk affedtning· Fosfatering· Rustbeskyttende grundmaling· Polyester-epoxy pulverlakering· Pulverlakering brændt ved 200 grader
Farve	RAL 9016
Driftstryk	6 bar
Anboring	4 sidetilslutninger 1/2" iht. ISO228 og 2 midtcentreret anboringer 3/4" eurokonus.
Type Vertical	Type22 – højde 2000 og 2200mm i længde 400 – 500 – 600 og 700mm
Type vertical Plan	Type 21 og 22 – højde 1800 – 2000 og 2200mm i længde 400 – 500 – 600 og 700mm
Type Line Vertical	Type 22 højde 2000mm og i længde 400 – 500 og 600mm
Garanti	Der ydes 10 års garanti på defekter forårsaget af materiale- eller produktionsfejl.
Medleveret tilbehør	Leveres med konsoller, skruer og plugs til montering, luftskrue, blindprop og aftapsventil.
Ekstra tibejør	Se tilbehør – Tilbehør Vertical side 41.

Tilslutningsmuligheder

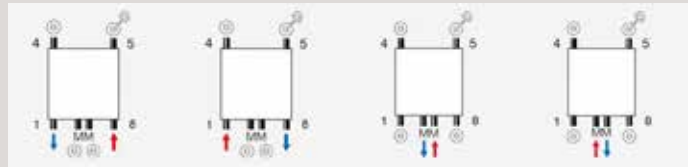

Vertical Compact

Type	VVS-nr.	Ydelse 70/40/20	Ydelse 60/30/20	Vægt
H2000-22-L400*	32.8882.224	828	460	38,28
H2000-22-L500*	32.8882.225	1035	574	46,61
H2000-22-L600*	32.8882.226	1242	689	55,93
H2000-22-L700*	32.8882.227	1449	804	65,25
H2200-22-L400*	32.8880.224	910	505	40,37
H2200-22-L500*	32.8880.225	1139	632	50,47
H2200-22-L600*	32.8880.226	1366	758	60,56
H2200-22-L700*	32.8880.227	1593	884	70,55

* Leveringstid 4-8 arbejdsdage

Vertical Plan

Type	VVS-nr.	Ydelse 70/40/20	Ydelse 60/30/20	Vægt
H1800-21-L400*	32.8871.184	683	398	36,51
H1800-21-L500*	32.8871.185	855	497	45,74
H1800-21-L600*	32.8871.186	1026	597	54,88
H2000-21-L400*	32.8871.124	760	442	40,28
H2000-21-L500*	32.8871.125	950	553	50,35
H2000-21-L600*	32.8871.126	1140	663	60,41
H2200-21-L400*	32.8872.124	836	486	44,13
H2200-21-L500*	32.8872.125	1045	608	55,16
H1800-22-L400	32.8871.284	715	397	40,12
H1800-22-L500*	32.8871.285	893	496	50,15
H1800-22-L600*	32.8871.286	1072	595	60,17
H1800-22-L700*	32.8871.287	1251	694	70,20
H2000-22-L400*	32.8872.224	795	440	44,66
H2000-22-L500*	32.8872.225	993	551	55,82
H2000-22-L600*	32.8872.226	1192	661	66,98
H2000-22-L700*	32.8872.227	1370	771	78,15
H2200-22-L400	32.8870.224	873	484	44,13
H2200-22-L500*	32.8871.225	1092	606	55,16
H2200-22-L600*	32.8870.226	1310	727	66,19
H2200-22-L700*	32.8870.227	1529	841	77,22





* Leveringstid 4-8 arbejdsdage

Vertical Line

Type	VVS-nr.	Ydelse 70/40/20	Ydelse 60/30/20	Vægt
H2000-22-L400*	32.8842.224	795	440	40,28
H2000-22-L500*	32.8842.225	993	551	50,35
H2000-22-L600*	32.8842.226	1192	661	60,41

* Leveringstid 4-8 arbejdsdage

Ekstra tilbehør Vertical

	Type	VVS-nr.
	HEIM MULTILUX TERMOSTAT HVID MULTILUX 4-ECLIPSE-SET MED HALO TERMOSTAT FØLER I HVID RAL 9016 TIL HÅNDKLÆDE RADIATORER OG VERTIKALE RADIATORER MED BUND ANBORING	32.8889.211
	HEIM MULTILUX TERMOSTAT KROM MULTILUX 4-ECLIPSE-SET MED HALO TERMOSTAT FØLER I HVID RAL 9016 TIL HÅNDKLÆDE RADIATORER OG VERTIKALE RADIATORER MED BUND ANBORING	32.8889.212
	VERTICAL HÅNDKLÆDESTANG INOX 40 CENTIMETER	32.8891.400
	VERTICAL HÅNDKLÆDESTANG INOX 50 CENTIMETER	32.8891.500
	VERTICAL HÅNDKLÆDESTANG INOX 60 CENTIMETER	32.8891.600
	VERTICAL HÅNDKLÆDESTANG INOX 70 CENTIMETER	32.8891.700

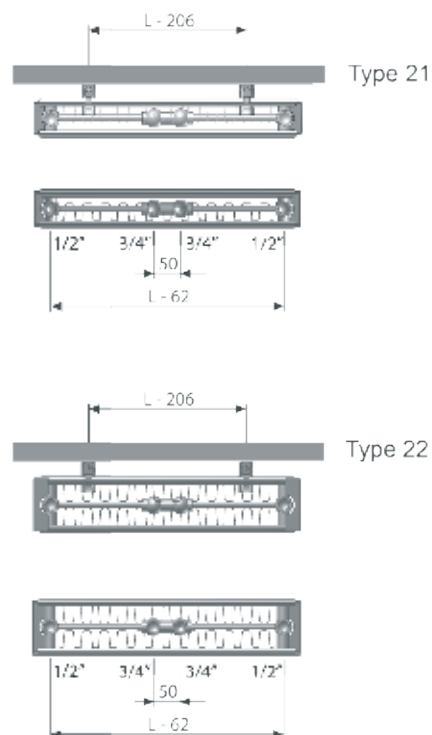
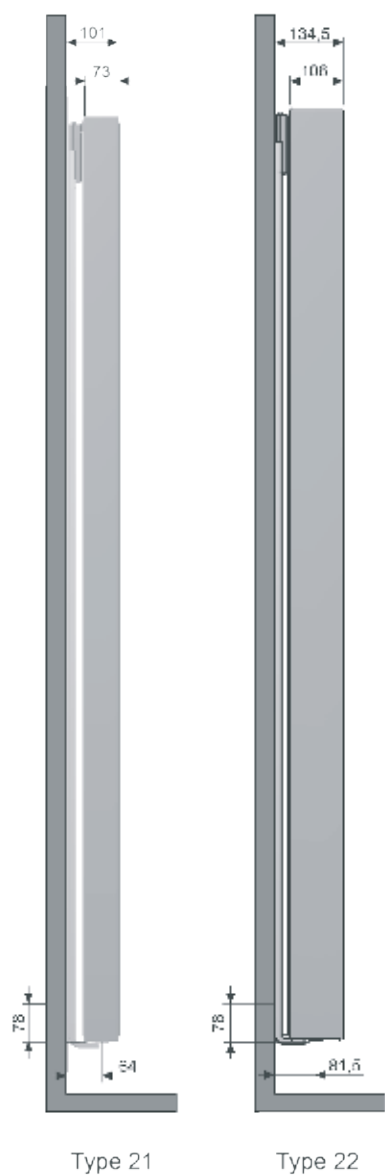

Basic-4 håndklæderadiator, krom

- 4 1/2" anboringer
- Ophængsbeslag, skruer og plugs for montage
- Blindprop og luftskrue
- Overflade krom
- Vandrette rør Ø21mm
- Lodrette rør D-profil 40x30mm

STØRRELSER

Højde	Længde	VVS-nr.
1172	500	32.8804.115
1172	600	32.8804.116

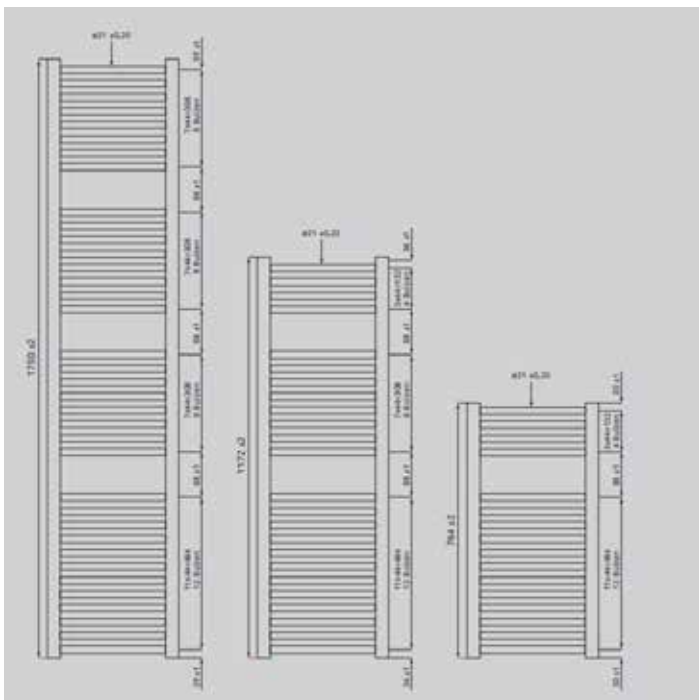



Basic-4 håndklæderadiator, hvid

- 4 ½" anbringinger
- Ophængsbeslag, skruer og plugs for montage
- Blindprop og luftskrue
- Farve hvid RAL 9016
- Vandrette rør Ø21mm
- Lodrette rør D-profil 40x30mm

STØRRELSER

Højde	Længde	VVS-nr.
1172	500	32.8800.115
1172	600	32.8800.116
1172	750	32.8805.117
1750	500	32.8805.175
1750	600	32.8805.176
1750	750	32.8805.177

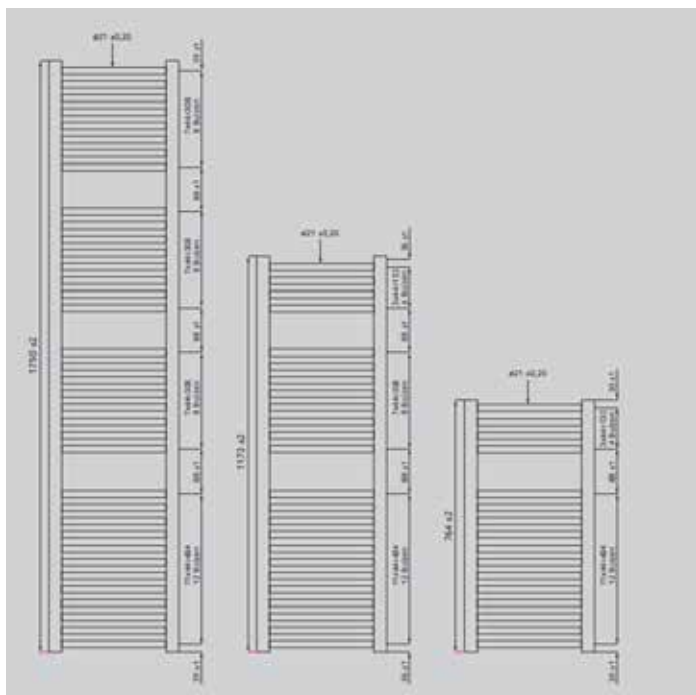

Basic 6 håndklæderadiator hvid

- 6 1/2" anboringer
- 2 midtertilslutninger centreret C/C 50mm
- Plastik-cover til midteranslutning
- Ophængsbeslag, skruer og plugs for montage
- Blindprop og luftskruer
- Farve hvid RAL 9016
- Vandrette rør Ø22mm
- Lodrette rør D-profil 40x30mm

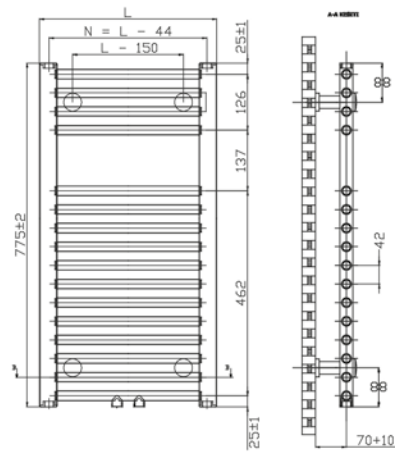
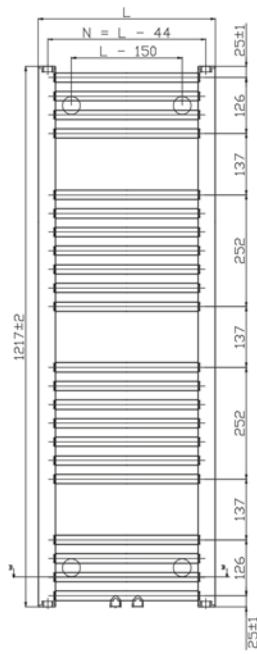
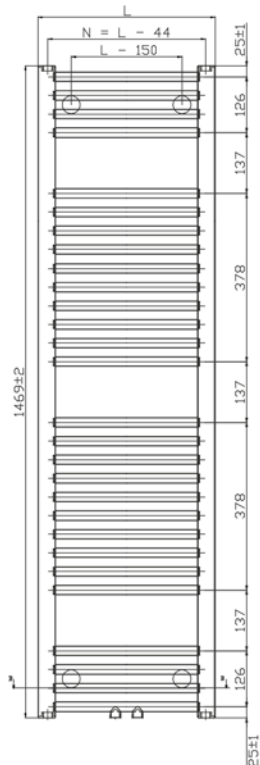
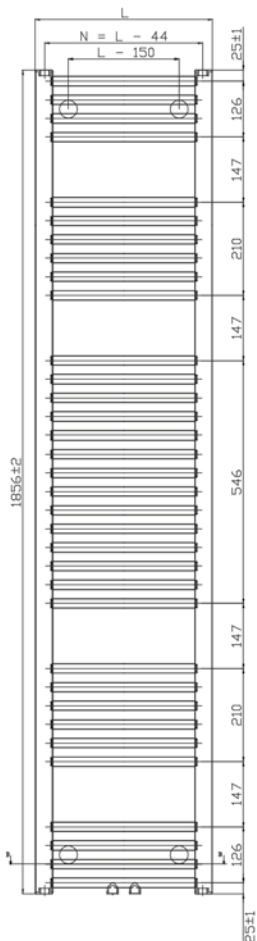

STØRRELSER

Højde	Længde	VVS-nr.
775	500	32.8805.075
1217	500	32.8805.125
1217	600	32.8805.126
1469	500	32.8805.155
1469	600	32.8807.146
1856	500	32.8805.185
1856	600	32.8805.186



Lina håndklæderadiator rustfri

- 6 1/2" anbringinger
- 2 midtertilslutninger centreret C/C 50mm
- Ophængsbeslag, skruer og plugs for montage
- Blindprop og luftskrue
- Overflade poleret rustfrit stål og børstet rustfrit stål
- Topmontering er ikke muligt på denne model

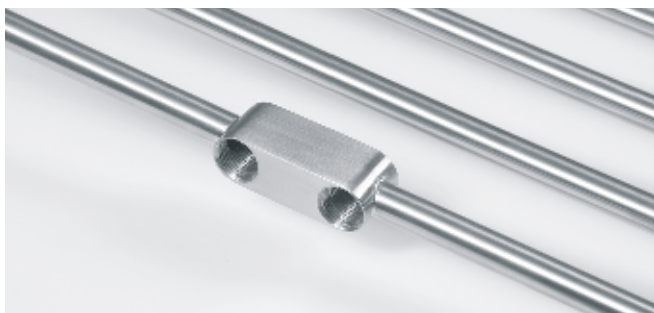

STØRRELSER - MAT POLERET



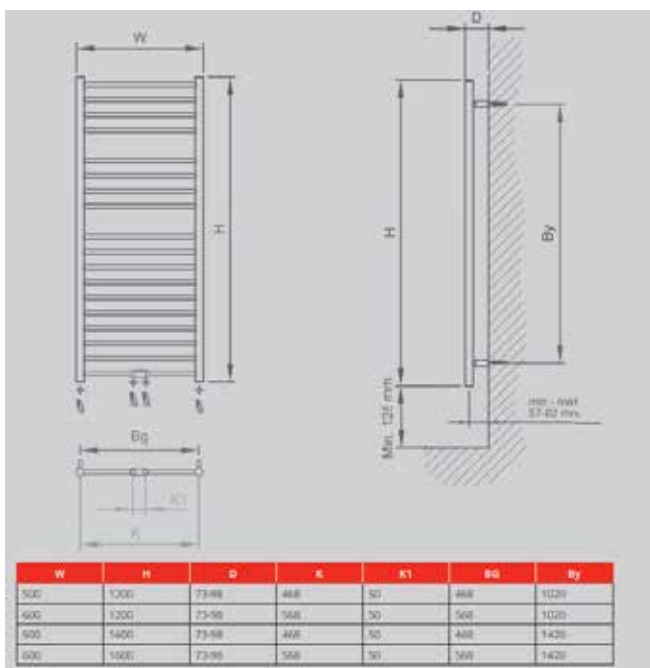

Højde	Længde	WVS-nr.
1200	500	32.8809.125
1200	600	32.8809.126
1600	500	32.8809.165
1600	600	32.8809.166



STØRRELSER - POLERET

Højde	Længde	WVS-nr.
1200	500	32.8809.425
1200	600	32.8809.426
1600	500	32.8809.465
1600	600	32.8809.466

Tilbehør håndklæderadiatorer krom

	Type	VVS-nr.
	SKANDI MANUEL VINKEL VENTILSÆT KROM	33.0981.924
	HÅNDKLÆDETØRRER VENTILSÆT 1/2 LIGE MANUEL	33.0879.004
	HÅNDKLÆDETØRRERVENTIL SÆT MED RETUR TERMOST 1/2 HØJRE	33.0883.304
	HÅNDKLÆDETØRRERVENTIL SÆT MED RETUR TERMOST 1/2 VENSTRE	33.0883.314
	RTX KROM VENTILSÆT MED RETURTERMOSTAT HØJRE MONTAGE	40.3238.304
	RAX KROM VENTILSÆT TERMOSTAT FREMLØB HØJRE MONTAGE	40.3238.204
	RTX KROM VENTILSÆT MED RETURTERMOSTAT VENSTRE MONTAGE	40.3239.204
	RAX KROM VENTILSÆT TERMOSTAT FREMLØB VENSTRE MONTAGE	40.3239.304
	HEIMEIER MULTILUX TERMOSTAT KROM TIL HKL.RAD. MED BUNDANBORING C/C 50MM	32.8889.212
	HEIMEIER MULTILUX TERMOSTAT KROM TIL HKL.RAD. MED BUNDANBORING C/C 50MM TIL 1 OG 2 STRENGS	32.8889.213
	TILSLUTNINGSSÆT KROM 80MM 1/2 RØR ROSET Ø65MM	33.0887.714

Tilbehør håndklæderadiatorer hvid

	Type	VVS-nr.
	HVID HÅNDKLÆDETØRRER VENTIL SÆT MED RETUR TERMOST 1/2 HØJRE VENDT	33.0883.340
	HVID HÅNDKLÆDETØRRER VENTIL SÆT MED RETUR TERMOST 1/2 VENSTRE VENDT	33.0883.350
	RTX HVID VENTILSÆT MED RETURTERMOSTAT HØJRE VENDT	40.3238.324
	RTX HVID VENTILSÆT MED RETURTERMOSTAT VENSTRE VENDT	40.3239.324
	RAX HVID VENTILSÆT TERMOSTAT FREMLØB HØJRE VENDT	40.3238.224
	RAX HVID VENTILSÆT TERMOSTAT FREMLØB VENSTRE VENDT	40.3239.224
	HEIMEIER MULTILUX TERMOSTAT HVID TIL HKL.RAD. MED BUNDANBORING C/C 50MM	32.8889.211
	HÅNDKLÆDE TØRRER VINKEL VENTILSÆT HVID MANUEL REGULERING UDEN RØR OG ROSET	33.0981.920
	TILSLUTNINGSSÆT HVID 80MM 1/2 RØR ROSET Ø65MM	33.0887.720

Nyhed

Nu kan du få rør i de mål du ønsker, leveret fra dag til dag

Solar har nu egen cuttermaskine og kan levere den ønskede mængde af præ-isoleret rør fra dag til dag – og dette med en dead-line på bestilling så sent som klokken 18.00.

webshop.solar.dk

Præisoleret rør PN6 til varme

	Type	VVS-nr.
	ENKELT RØR 25X2,3-125MM PN6 TIL VARME YDERKAPPE Ø125MM	08.7801.025
	ENKELT RØR 32X2,9-160MM PN6 VARME YDERKAPPE Ø160MM	08.7801.032
	ENKELT RØR 40X3,7-160MM PN6 TIL VARME YDERKAPPE Ø 160MM	08.7801.034
	DOBBELT RØR 2X25X2,3-160MM PN6 TIL VARME YDERKAPPE Ø 160MM	08.7802.025
	DOBBELT RØR 2X32X2,9-160MM PN6 TIL VARME YDERKAPPE Ø 160MM	08.7802.032
	DOBBELT RØR 2X40X3,7-160MM PN6 TIL VARME YDERKAPPE Ø 160MM	08.7802.040
	QUADRO RØR 2 X 32X2,9 - 1 X 25X3,5 - 1 X 20X2,8 TIL VARME OG VAND. 2X32MM PN6 TIL VARME OG 1X25MM OG 1,20MM PN10 TIL VAND. YDERKAPPE Ø160MM	08.7818.932

Præisoleret rør PN10 til vand

	Type	VVS-nr.
	ENKELT RØR 18X2,5-90MM PN10 TIL VAND YDERKAPPE Ø90MM	08.7360.018
	ENKELT RØR 28X4,0-125MM PN10 VAND YDERKAPPE Ø125MM	08.7360.028
	ENKELT RØR 32X4,4-125MM PN10 TIL VAND YDERKAPPE Ø125MM	08.7360.032
	DOBBELT RØR 1X28X4 - 1X18X2,5-125MM PN10 YDERKAPPE Ø125MM	08.7360.128
	DOBBELT RØR 1X32X4,4 - 1X22X3,0-125MM PN10 YDERKAPPE Ø125MM	08.7360.132











Fittings PN6 til varme

	Type	VVS-nr.
	OVERGANGS NIPPEL 25X2,3MM X 3/4" PN6 TIL VARME	08.8048.025
	OVERGANGS NIPPEL 32X2,9MM X 1" PN6 TIL VARME	08.8048.032
	OVERGANGS NIPPEL 40X3,7MM X 1 1/4" PN6 TIL VARME	08.8048.040

Fittings PN10 til vand

	Type	VVS-nr.
	OVERGANGS NIPPEL 18X2,5MM X 1/2" PN10 TIL VAND	04.6707.018
	OVERGANGS NIPPEL 20X2,8MM X 3/4" PN10 TIL VAND	04.6707.932
	OVERGANGS NIPPEL 22X3,0MM X 3/4" PN10 TIL VAND	04.6707.022
	OVERGANGS NIPPEL 25X3,5MM X 3/4" PN10 TIL VAND	04.6707.982
	OVERGANGS NIPPEL 28X4,0MM X 1" PN10 TIL VAND	04.6707.028
	OVERGANGS NIPPEL 32X4,4MM X 1" PN10 TIL VAND	04.6707.032

Tilbehør præisoleret rør

	Type	VVS-nr.
	STÆNKHÆTTE ENKEL RØR 18MM YDERKAPPE 90MM	08.8058.018
	STÆNKHÆTTE ENKEL RØR 25MM YDERKAPPE 125MM	08.8058.025
	STÆNKHÆTTE ENKEL RØR 32MM YDERKAPPE 160MM	08.8058.032
	STÆNKHÆTTE ENKEL RØR 40MM YDERKAPPE 160MM	08.8058.040
	STÆNKHÆTTE TIL DOBBEL RØR 25MM YDERKAPPE 160MM	08.8058.125
	STÆNKHÆTTE TIL DOBBEL RØR 32MM YDERKAPPE 160MM	08.8058.132
	STÆNKHÆTTE TIL DOBBEL RØR 28MM OG 18MM YDERKAPPE 125MM	08.8058.228
	STÆNKHÆTTE TIL DOBBEL RØR 32MM OG 22MM YDERKAPPE 125MM	08.8058.232
	STÆNKHÆTTE TIL DOBBEL RØR 40MM YDERKAPPE 160MM	08.8058.140
	STÆNKHÆTTE TIL QUADRORØR 2X32MM - 1X25MM - 1X20MM YDERKAPPE 160MM	08.8058.932
	KRYMPEHÆTTE TIL RØR 32 OG 40MM PASSENDE TIL YDERKAPPE 75 OG 90MM	08.8059.128
	KRYMPEHÆTTE TIL RØR 40 OG 50MM PASSENDE TIL YDERKAPPE 125MM	08.8059.150
	KRYMPEHÆTTE TIL RØR 63MM PASSENDE TIL YDERKAPPE 125MM	08.8059.151
	KRYMPEHÆTTE DOBBEL TIL RØR 32MM OG 25MM PASSENDE TIL YDERKAPPE 160MM	08.8059.233
	KRYMPEHÆTTE DOBBEL TIL RØR 40MM PASSENDE TIL YDERKAPPE 160MM	08.8059.240
	KRYMPEHÆTTE UNIVERSAL DOBBEL TIL RØR 18 - 20 - 25 - 28 OG 32MM PASSENDE TIL YDERKAPPE 125MM	08.8059.125
	KRYMPEHÆTTE UNIVERSAL DOBBEL TIL RØR 25 - 32 - 40 OG 50MM PASSENDE TIL YDERKAPPE 160MM	08.8059.450
	KRYMPE KAPPE PASSENDE TIL YDERKAPPE 75 OG 90MM LÆNGDE 220MM	08.8057.285
	KRYMPE KAPPE PASSENDE TIL YDERKAPPE 125MM LÆNGDE 220MM	08.8057.325
	KRYMPE KAPPE PASSENDE TIL YDERKAPPE 160MM LÆNGDE 220MM	08.8057.360
	YDER KAPPE ISOLERET PASSENDE TIL YDERKAPPE 75 - 90 OG 125MM	08.8050.123
	YDER KAPPE ISOLERET PASSENDE TIL YDERKAPPE 125 - 160 OG 200MM	08.8050.198
	YDER KAPPE ISOLERET T-STYKKE PASSENDE TIL YDERKAPPE 75 - 90 OG 125MM	08.8042.123
	YDER KAPPE ISOLERET T-STYKKE PASSENDE TIL YDERKAPPE 125 - 160 OG 200MM	08.8042.198
	REDUKTIONS KRYMPE KAPPE - BRUGES NÅR DER REDUCERES FRA YDERKAPPE 160MM TIL YDERKAPPE 75 OG 90MM	08.8053.160

Timelevering

Grøn Fastbox

Vidste du, at du kan spare minimum 20 %
i CO2-udledning pr. Solar Fastbox-levering?
Og nogle gange endnu mere!
Se mere på www.solar.dk/fastbox



solar | fastbox



11300621

Hovedkontor:

Solar Danmark A/S
Industrivej Vest 43
6600 Vejen
Tlf. 76 52 70 00
www.solar.dk

Kundecentre:

København
Vingelodden 10
2200 København N
Tlf. 76 52 70 00

Fastbox-center Øst
Banemarksvej 80
2605 Brøndby
Tlf. 76 52 70 00

Odense
Sivlandvænget 1
5260 Odense S
Tlf. 76 52 70 00



Sønderborg
Damgade 71
6400 Sønderborg
Tlf. 76 52 70 00

Vejle
Niels Bohrs Vej 2
7100 Vejle
Tlf. 76 52 70 00

Åbyhøj, (Aarhus)
Søren Frichs vej 50
8230 Åbyhøj
Tlf. 76 52 70 00

Aalborg
Håndværkervej 13
9000 Aalborg
Tlf. 76 52 70 00

